



HP-OWER ONE R

70R – 90R – 120R – 120RT - 140R – 160RT – 180R
70RK – 90RK – 120RK – 140RK – 160RTK – 180RK

CONTROLLER INTERFACE

INDEX

1	CONSERVATION OF THE MANUAL	3
1.1	GRAPHIC SYMBOLS	3
2	PERMITTED USES	3
3	GENERAL SAFETY RULES	3
3.1	PERSONAL SAFETY EQUIPMENT	3
3.2	WORKERS' HEALTH AND SAFETY	4
4	PURPOSES AND CONTENTS OF THE MANUAL	5
5	USER – CONTROLER INTERFACE	5
5.1	MENU STRUCTURE DIAGRAM	6
5.2	MENU'S CONTENTS	6
5.2.1	Setpoint's menu [SEt]	7
5.2.2	Password's menu [PSS]	7
5.2.3	Sensors' menu [tP]	7
5.2.4	Alarms' menu [Err]	7
5.2.5	Digital inputs' menu [Id]	7
5.2.6	Parameters' menu [PAr]	7
5.2.7	Operation's hours menu [oHr]	8
5.2.8	Firmware Version [Fir]	8
5.2.9	Alarm History [HiSt]	8
5.2.10	USB's menu [USb]	8
5.3	DISPLAY	9
5.4	LED	9
5.5	INPUT/OUTPUT (I/O) PORTS	10
6	DYNAMIC SET-POINT ADJUSTMENT	11
6.1	SETTINGS FOR STANDARD CLIMATE CURVES	11
7	SET-POINT ADJUSTMENT FROM 0-10V INPUT	12
8	CIRCULATOR	12
8.1	OPERATION BY MEAN OF THERMOREGULATOR	12
8.2	OPERATION BY THERMOREGULATOR WITH PERIODIC ACTIVATION	13
8.3	OPERATION WITH ACTIVE ELECTRIC HEATER	13
8.4	CONTINUOUS OPERATION	13
8.5	PROPORTIONAL ADJUSTMENT OF THE PUMP	13
8.6	PURGING THE SYSTEM	14
9	COMPRESSOR CONTROL LOGIC	14
9.1	INVERTER COMPRESSOR CONTROL IN COOLING MODE	15
9.2	HEATING FUNCTION CONTROL	15
10	HEAT DISSIPATION FAN MOTOR CONTROL	15
10.1	FAN SILENT MODE	16
10.2	FAN SPEED CONTROL IN COOLING MODE	16
10.3	FAN SPEED CONTROL IN HEATING MODE	16
11	CONTROL FUNCTIONS	17
11.1	ANTIFREEZE PROTECTION ELECTRIC HEATERS (ONLY FOR -K VERSION)	17
11.2	ACTIVATION OF SANITARY (DOMESTIC) HOT WATER PRODUCTION	17
11.2.1	Sensor memorization in heating mode	18
11.3	HEATING MODE ON SANITARY ACCUMULATION	19
11.4	MODE ON SANITARY ACCUMULATION	19
11.5	REMOTE FUNCTIONS	20
11.5.1	ON/OFF	20
11.5.2	Summer/Winter mode commutation	20
11.5.3	Sanitary mode call from digital input	20
11.6	REMOTE SENSOR FOR THE WATER TEMPERATURE OF THE PLANT CIRCUIT	20
11.7	AUXILIARY ELECTRIC HEATER	21
11.7.1	Plant circuit electric heater	21
11.7.2	Auxiliary electric heater of the plant in defrost cycle	21
11.7.3	Electric heater of sanitary water production	21

11.7.4	<i>A single auxiliary electric heater for both plant system/dhw production</i>	22
11.8	SELECTION MODE OF AUXILIARY ELECTRIC HEATERS	22
11.9	MANAGEMENT OF THE CIRCULATOR WITH ACTIVE ELECTRIC HEATER	22
11.10	BOILER ENABLEMENT	22
11.11	ACTIVATION OF AUXILIARY ELECTRIC HEATERS AND BOILER DURING THE JOINT AND IN SUBSTITUTION OPERATION TO THE COMPRESSOR OF THE HEAT PUMP	22
11.11.1	<i>Operation in heat pump mode</i>	23
11.11.2	<i>In joint operation (Zone I)</i>	23
11.11.3	<i>In joint operation (Zone II)</i>	23
11.11.4	<i>In substitution operation</i>	23
11.12	OPERATION ZONE - ACTIVATION OF THE AUXILIARY ELECTRIC HEATER AND BOILER (PLANT CIRCUIT WATER TEMPERATURE SENSOR IS NOT ENABLED)	24
11.12.1	<i>Auxiliary systems offset's management</i>	27
11.13	SIGNALIZATIONS OF FUNCTIONS	27
11.13.1	<i>Plant's seasonal operation mode</i>	27
11.13.2	<i>Alarm</i>	27
11.13.3	<i>Heat pump lockout</i>	28
11.13.4	<i>Defrosting</i>	28
11.14	DEFROSTING CYCLE	28
11.15	COMPRESSOR CRANKCASE HEATER	28
11.16	MINIMUM Hz	28
11.17	MAXIMUM Hz	28
11.18	DOUBLE SET-POINT (WITHOUT REMOTE CONTROL TOUCH SCREEN)	28
11.18.1	<i>Control settings</i>	30
12	AVAILABLE FUNCTIONS WITH TOUCH SCREEN CONTROL PANEL ACCESSORY	31
12.1	MANAGEMENT OF SECONDARY CIRCULATOR (WITH ROOM THERMOSTAT)	31
13	USER'S AND INSTALLER'S ALLOWED CONFIGURATIONS	31
14	ALARMS	39
14.1	WATER FLOW SWITCH ALARM [E006]	39
14.2	HIGH TEMPERATURE [E018]	39
14.3	ANTI-FREEZING [E005]	39
14.4	SENSOR ALARMS [E611÷E692]	39
14.5	TIMEOUT INVERTER [E801]	39
14.6	INVERTER [E851÷E971]	39
14.7	REMOTE ON/OFF [E00]	39
14.8	HIGH PRESSURE [E001]	39
14.9	HIGH PRESSURE FLOW SWITCH (IN SERIES WITH THE COMPRESSOR OUTLET PROBE) [E641]	39
14.10	LOW PRESSURE [E002]	39
14.11	DRIVER LIMITATION [E008]	39
14.12	4-WAY VALVE [E041]	40
14.13	DOMESTIC HOT WATER PROTECTION [E042]	40
14.14	POWER SUPPLY FAILURE	40
14.15	[E020] INVERTED TRANSDUCERS	40
14.16	USER BLOCK ALARM LIST	40
15	MODBUS VARIABLES	41





1 CONSERVATION OF THE MANUAL

The manual has to be always kept for future reference. It has to be stored in a safe place, away from dusts and moisture. It has to be also available and accessible to all users who shall consult it any time they are in doubt on how to operate the equipment. The company reserves the right to modify its products and related manuals without necessarily updating previous versions of the reference material. It declines also any responsibility for possible inaccuracies in the manual if due to printing or transcription errors.

The customer shall store any updated copy of the manual or parts of it delivered by the manufacturer as an attachment to this manual.

The company is available to give any detailed information about this manual and to give information regarding the use and the maintenance of its own machines.

1.1 GRAPHIC SYMBOLS

	<i>Indicates prohibited operations.</i>
	<i>Indicates operations that can be dangerous for people and/or disrupts the correct operation of the equipment.</i>
	<i>Electric shock hazard - risk of electric shock.</i>
	<i>Indicates important information that the operator has to follow in order to guarantee the correct operation of the equipment in complete safety. It indicates also general notes.</i>

2 PERMITTED USES

The company excludes any contractual and extra contractual liabilities for damages caused to persons, animals or objects, by incorrect installation, setting and maintenance, improper use of the equipment, and the partial or superficial reading of the information contained in this manual.

These units have been designed only for heating and/or cooling water. Any other use not expressly authorized by the manufacturer is considered improper and therefore not allowed.

The location of the plant, the hydraulic and electrical circuits must be established by the planting designer and must take into account both technical requirements as well as any applicable local laws and authorized specifications.





The execution of all works must be performed by skilled and qualified personnel, competent in the existing rules in different countries.

3 GENERAL SAFETY RULES

Before beginning to operate on the units every user has to be perfectly knowledgeable about the functions of the equipment and its controls and has to have read and understood the information listed in the user's-installer's manual.

3.1 PERSONAL SAFETY EQUIPMENT

During the operating and maintaining works, use the following personal protective equipment.

	<i>Protective clothing: Maintenance men and operators have to wear protective clothing that complies with the basic safety requirements currently in force. In case of slippery floors, users have to wear safety shoes with non-slip soles.</i>	
	<i>Gloves: During maintenance or cleaning operation protection gloves have to be used</i>	
		<i>Mask and goggles: Respiratory protection (mask) and eye protection (goggles) should be used during cleaning and maintenance operations.</i>

Consult the user manual - installer accompanied with the unit.

3.2 WORKERS' HEALTH AND SAFETY

The European Community has adopted a number of directives on workplace's health and safety, which include 89/391/CEE, 89/686/CEE, 2009/104/CE, 86/188/CEE and 77/576/CEE directives. Every employer shall implement such provisions and ensure that their workers to respect them.



It's forbidden:

- *To remove and/or tamper with any safety device.*
- *The access to the electrical board by unauthorized persons.*
- *To carry out any work on the equipment under voltage.*
- *To touch the equipment if you are not allowed.*
- *The use of the appliance by children or unassisted disabled persons.*
- *To touch the appliance when barefoot or parts of the body are wet or damp.*
- *To clean the unit when the power is 'ON'.*
- *To pull, remove or twist the electrical cables coming out from the unit.*
- *To step with your feet on the appliance, sit down and/or place any type of object.*
- *To spray or pour water directly on the unit.*
- *To dispose of, abandon or leave within reach of children packaging materials (cardboard, staples, plastic bags, etc.) as they may represent an environmental and health hazards.*
- *To tamper with or replace parts of the equipment without the specific consent of the manufacturer. The manufacturer shall have no whatsoever civilian or penal responsibility in case of unauthorized operations.*



WARNING:

- *Before proceeding, you should read the user's-installer's manual accompanying the appliance.*
- *All the operations described below must be carried out only by QUALIFIED PERSONNEL.*
- *The wiring to the terminal block must be performed by qualified personnel.*
- *Any routine and/or not-routine maintenance operation shall be carried out when the equipment has been shut down, disconnected from electric power supply.*
- *Do not put neither your hands nor insert screwdrivers, spanners or other tools into moving parts of the equipment.*
- *The equipment's supervisor and the service man have to receive suitable training for performing their tasks in safety.*
- *The access to the electric panel is limited to authorized personnel only.*
- *Operators have to know how to use personal protective devices and have to know the accident-prevention guidelines contained in national and international laws and norms.*
- *The operator's workplace has to be kept clean, tidy and free from objects that may prevent free movements. Appropriate lighting of the work place shall be provided so as to allow the operator to carry out the required operations safely. Poor or too strong lighting can cause risks.*
- *Ensure that the work places are always adequately ventilated and that aspirators are working, in good condition and in compliance with the requirements of the laws in force.*
- *Not all the configurations can be simultaneously enabled and/or changed.*
- *Other values different than those of default can ensure the proper operation of the unit, in case of doubt about the value to be set contact please our office.*
- *The company excludes any contractual and extra contractual liabilities for damages caused to persons, animals or objects, by incorrect installation, setting and maintenance, improper use of the equipment, and the partial or superficial reading of the information contained in this guide.*



- *The supply voltage's fluctuations cannot exceed $\pm 10\%$ of the nominal value. If this tolerance should not be respected, please contact our technical department.*
- *The power supply should respect the listed limits on the technical label on the unit: failing this, warranty will not be valid immediately. Before any operation on the unit, be sure that the power supply is disconnected.*
- *Phase, neutral and ground connections should be respected.*
- *The power supply cables must be sized correctly considering the TECHNICAL DATA shown in the User Manual - installer accompanied to the unit. We recommend a minimum cross section of 4mm^2 and a maximum length of 10m.*
- *Install upstream of each unit an adequate protection and disconnection device of the electric power with delayed characteristic curve, with at least 3 mm contact opening and with an adequate capacity of breaking and differential protection. The capacity of the magneto-thermic circuit breaker must conform to the electric consumption of the unit; see TECHNICAL DATA reported in the user's-installer's manual accompanying the unit. (Consideration should be taken of any eventual auxiliary*

electric heater).

- *If not present in the network, we recommend the installation of a differential current device (RCD) that has a rated operating differential current that does not exceed 30mA*
- *A good grounding is required; the manufacturer is not responsible for damage caused in case of lack of good grounding.*
- *In case of maintenance, the unit must be disconnected from the power supply, the power cable plug must be easy for pulling it out from the power socket by the operator for having possibility to check the unit from anywhere, the plug should remain disconnected.*
- *Use cables that meet the regulations in force in different countries.*
- *Be sure, after about 10 minutes of operation the screws on the power supply terminal block that are well fixed.*



Requirements before performing electrical work on the control panel:

- *Turn off the unit from the control panel ("OFF" displayed).*
- *Put the switch "QF" general differential on OFF position.*
- *Wait for 15 seconds before getting access to the electric board.*
- *Check the ground connection before beginning any operation.*
- *Be sure that you are well insulated from the ground, with dry hands and feet, or by using insulating platforms and gloves.*
- *Check that there is no foreign material near the system.*

4 PURPOSES AND CONTENTS OF THE MANUAL

This manual provides basic information for the installation, operation and maintenance of HP_OWER ONE units.

It is addressed to machine operators and it enables them to use the equipment efficiently, even if they do not have any previous specific knowledge of it.

Not all the described functions can be individually and/or simultaneously selected. Please contact the technical office for any information.

The manual describes the characteristics of the equipment at the time in which it is being put on the market; therefore, it may not include technological improvements introduced later by the company as part of its constant endeavour to enhance the performance, ergonomics, safety and functionality of its products.

The company introduces also technological improvements and is not constrained to update the manuals for previous versions of appliances that could not be compatible. So make sure to use the manual supplied with the installed appliance.

It's recommended to the users to follow the instructions contained in this booklet, especially those concerning the safety and routine maintenance.

5 USER – CONTROLER INTERFACE

The unit is complete with display accessible via a transparent polycarbonate door with IP 67 protection degree. The interface consists of a variable text part and a series of icons identifying the operation of the unit as shown in the table below.





It is used to select the operating mode, and to initialize the manual resetting alarms. The operating mode changes as per the sequence below each time you press the Mode button:
 off → cool → heat → off
 If the Domestic Hot Water (DHW) mode is enabled, the sequence is as follows:
 off → cool → cool+san → heat → heat+san → off
 During the parameters' setting, this button can be used to go back to the previous level.

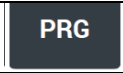

It allows you to enter into the setting menu parameters and to select the cool/summer, heat/winter and DHW set point value.



UP button: In the setting mode, this button allows you to move up to a higher menu or to increase the value of a parameter when you are in the "edit" mode.



DOWN button: In the setting mode, this button allows you to shift to a lower menu or to decrease the value of a parameter when you are in the "edit" mode.

5.1 MENU STRUCTURE DIAGRAM

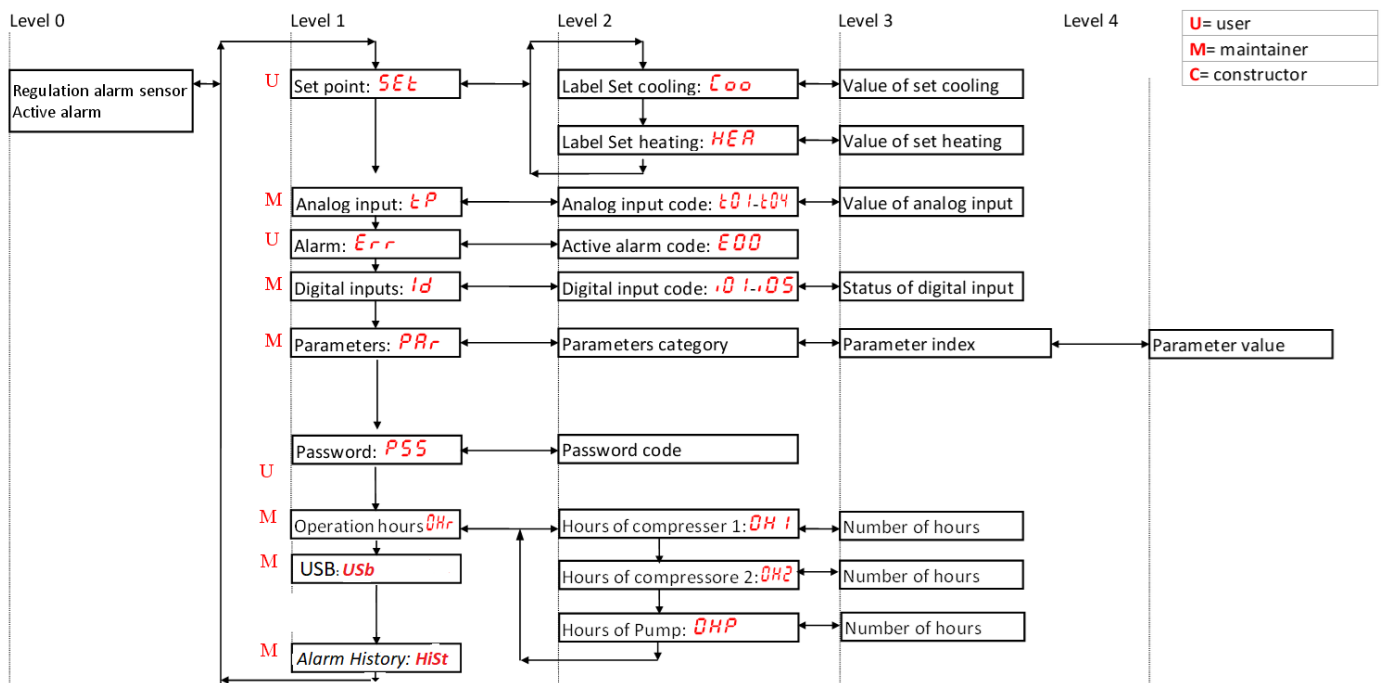

Level 0 (U) = always visible

Level 1 (M) = it's visible if you enter the maintainer or manufacturer password.

Level 2 (C) = it's visible if you enter the constructor password.

Level 3 (A) = it's visible only via Modbus.

5.2 Menu's contents

The main functions of the menus are listed below, especially when there are some unambiguous functions. The main menu manages the following parameters:

MENU	LABEL	LIVEL OF PASSWORD	OTHER CONDITIONS
Setpoint	SEt	User	Not accessible if the unit is connected to Touch Screen
Sensors	tP	Installer	---
Alarms	Err	User	Only in case of active alarms
Digital inputs	Id	Installer	---
Parameters	PAr	Installer	---
Password	PSS	User	---
Number of operating hours	oHr	Installer	---
USB	USb	Installer	Only if the USB flash drive is present with its files
Firmware Version	Fir	Installer	Version, Revision and Sub
Alarm History	HiSt	Installer	Only if you have data in the history

Enter in the password's menu and insert its "password code" in order to enable an access with a greater privilege. Note that, once you exit completely from the menus, the password permission will be lost and you should to re-enter it in order to get access again.

5.2.1 Setpoint's menu [SEt]

You can display and modify the different set-points.

SET-POINT	DESCRIPTION	UNIT	DEFAULT	RANGE
Coo	First set-point in the summer	°C	7.0	H03 ÷ Co2
HEA	First set-point in the winter	°C	45.0	He2 ÷ H01
*SAn	DHW set-point	°C	48.0	H02 ÷ H01
Coo2	Second set-point in the summer	°C	18.0	Coo ÷ H03
HEA2	Second set-point in the winter	°C	35.0	H02 ÷ Hea
**rCoo	---	°C	15.0	0.0 ÷ 80
**rHEA	---	°C	30.0	0.0 ÷ 80
**ACS	---	°C	0.0	0.0 ÷ 80

(*) if the DHW function is active

(**) Menu not active

5.2.2 Password's menu [PSS]

Enter and confirm the password for the desired access level. The control panel will automatically open the desired access level and then the voices which can be enabled from this level will be visible.

5.2.3 Sensors' menu [tP]

The value of the different sensors will appear. The number of visible sensor depends on the presence or not of the I/O expansion modules.

Particular cases:

- Err = Sensor is faulty
- --- = Sensor not used (no function is associated to such sensor)

tp	DESCRIPTION	Unit
t01	Water inlet temperature	(°C)
t02	Water outlet temperature	(°C)
t03	Compressor intake temperature	(°C)
t04	Compressor discharge temperature	(°C)
t05	Outdoor air temperature	(°C)
t06	Sanitary Water tank temperature (if available)	(°C)
t07	External Water temperature sensor (if available)	(°C)
t09	Low pressure	(bar)
t10	High pressure	(bar)

5.2.4 Alarms' menu [Err]

This menu appears only in case of alarms warning. It allows you to check all active alarms. Note that, the alarms are divided by circuit for multi-circuit units (the ALCx label allows to enter to the alarms of the circuit number x).

5.2.5 Digital inputs' menu [Id]

You can check the status of the digital inputs as below:

0 = inactive input

1 = active input

----=input not configured

5.2.6 Parameters' menu [PAr]

The parameters are collected into groups; each group is identified by a three-digit code, while the index of each parameter is preceded by a letter.

DESCRIPTION	GROUP'S IDENTIFICATION CODE	PARAMETER'S INDEX	VISIBILITY
Configuration	CnF	H01-	INSTALLER
Compressor	CP	C01-	INSTALLER
Fan motor*	FAn	F01-	INSTALLER
Alarms	ALL	A01-	INSTALLER
Regulation	rE	b01-	INSTALLER
Pump	PUP	P01-	INSTALLER
Electric heaters	Fro	r01-	INSTALLER
Defrosting	dFr	DO1-	INSTALLER
Maximum Hz	LbH	L01-	INSTALLER
Electronic valve	EEu	U01-	INSTALLER
Offset	oFF	o01-	INSTALLER

*Only for some models

Note that a certain group is visible only if there is at least a common parameter belonging to the same group and to the current visible level.

5.2.7 Operation's hours menu [oHr]

You can display the number of operating hours of the compressors and of the pumps.

Press the ESC button for 3 seconds to resets the actual number of operating hours. Note that, you can enter into this menu only by mean of password.

5.2.8 Firmware Version [Fir]

Firmware version (uEr), Firmware revision (rEu) and sub (SUb) can be displayed

Note that the menu can only be accessed with a password.

5.2.9 Alarm History [HiSt]

View the alarm history list, even if returned.

5.2.10 USB's menu [USb]

The available functions through the use USB flash drive that is connected to the board are indicated below.

 WARNING	<i>All the operations with installer visibility must be carried out by qualified personnel.</i>
	<i>The company excludes any contractual and extra contractual liabilities for damages caused to persons, animals or objects, by incorrect installation, setting and maintenance, improper use of the equipment, and the partial or superficial reading of the information contained in this manual.</i>

5.2.10.1 FIRMWARE UPGRADE [UPdF]

You can update of the controller's firmware in case of new versions release, this can be done by mean of a USB flash dive via its proper port on the controller.

For the update:

1. Copy the updated files in the main directory of a USB pen-drive;
2. Place the unit in standby mode and turn it off, placing the main switch on OFF position;
3. Introduce the USB pen-drive into its port on the controller;
4. Turn ON the unit by placing the main switch in ON position;
5. Open the page of the parameters PRG→PSS→PRG→(introduce the maintainer password)→PRG→USB→UPdF→PRG.
The automatic firmware updating process starts with the selection of this option, the display shows the transferred data in Kilobytes. When the update is completed the display shows "boot" then the LEDs will light up in sequence.
6. .Once the update is completed, the board returns to normal operation and the appliance is ready to start operation.
7. Turn off the unit by placing the main switch in OFF position.
8. Remove the USB pen-drive from its port.
9. Feed the unit by placing the main switch on the ON state.

5.2.10.2 PARAMETERS UPGRADE [UPPA]

You can update the parameters in case of new ones, using the USB pen-drive via its port on the controller.

For the updating:

1. Copy the update files in the main directory of a USB pen-drive;
2. Place the unit in standby mode and turn it off, placing the main switch in OFF position;
3. Introduce the USB pen-drive in its port on the controller;
4. Turn ON the unit by placing the main switch in the ON position;
5. Enter at the page of the parameters PRG→PSS→PRG→(introduce the maintainer password)→PRG→USB→UPPA→PRG.
The automatic parameters update process starts with the selection of this option, the display shows the transferred data in Kilobytes. When the update is completed the display shows "boot" then the LEDs will light up in sequence.
6. Once the update is completed, turn off the unit by placing the main switch on OFF position.
7. Remove the USB pen-drive from its port.
8. Turn ON the unit by placing the main switch on the ON state

5.2.10.3 EXPORT PARAMETERS [ESP]

You can export the parameters from control board to USB pen, using the USB pen-drive via its port on the controller.









For exporting:

- 1 Place the unit in standby mode and turn it off, placing the main switch in OFF position;
- 2 Introduce the USB pen-drive in its port on the controller;
- 3 Turn ON the unit by placing the main switch in the ON position;
- 4 Enter at the page of the parameters PRG→PSS→PRG→(introduce the maintainer password)→PRG→USB→ESP→PRG.
The automatic parameters export process starts with the selection of this option, the display shows the transferred data in Kilobytes. When the update is completed the display shows "boot" then the LEDs will light up in sequence.
- 5 Once the update is completed, turn off the unit by placing the main switch on OFF position.
- 6 Remove the USB pen-drive from its port.
- 7 Turn ON the unit by placing the main switch on the ON state

5.3 DISPLAY

In Normal view displays, the outlet water temperature reported to tenths of degrees, or the alarm code if at least an alarm is active. In case of multiple alarms activation, it will display the first alarm, while the second appears when the first is reset. Into the menu mode, the display depends on the current position where you are.

5.4 LED

	Compressor LED	ON if the compressor is running OFF if the compressor is off FLASHING if timings are in progress waiting for compressor's start up.
	Sanitary water LED	ON if sanitary mode is active OFF if the sanitary mode is not active FLASHING if sanitary production in progress (sanitary valve is active)
	Defrosting LED	ON in defrost operating mode OFF if defrosting mode is disabled or completed FLASHING if defrosting cycle interval's time is in progress.
	Antifreeze electric heater LED	The LED is ON if the antifreeze electric heater is active.
	Water pump LED	The LED is ON if the water pump is running.
	Alarm LED	The LED is ON if an alarm is activated.
	Heat LED	The LED is ON if the unit is in the heating mode operation.
	Cool LED	LED is ON if the unit is in the cooling mode operation.

5.5 INPUT/OUTPUT (I/O) PORTS

The I/O (inputs and outputs) that can be set to enable the control functions are listed below.

In order to set the I/O please enter with service password to the parameters **PRG**→**PSS**→**PRG** → (insert the service password) → **PRG** → **Par** → **PRG** → **CnF**.

Ports	Parameter	Terminals	Factory Setting		Description
			Value	Function	
ST6	H17	17.1 / 17.2	0	Sanitary Water tank temperature sensor (not set by default)	Programmable analog input with NTC sensor 10kΩ at 25°C β 3435. (Configuration as a digital input is possible)
ST7	H18	19.1 / 19.2	0	External Water temperature sensor (not set by default)	Programmable analog input with NTC sensor 10kΩ at 25°C β 3435. (Configuration as a digital input is possible)
ST10	H22	22.1 (-) 22.2 (+)	0	Change set point	Under voltage input 0-10Vdc (interfacing with an external Controller)
ID2	H46	16.1 / 16.2	0	Remote summer/winter commutation (See paragraph 11.5.2)	Voltage free contact digital input To enable the function, see paragraph (See paragraph 11.5.2)
ID3	H47	15.1 / 15.2	2	Remote on/off (See paragraph 11.5.1)	Voltage free contact digital input Function active by default
ID9	H53	20.1 / 20.2	0	Sanitary call from digital input / double set point	Voltage free contact digital input
DO3	H81	6.1(phase) 6.2 (neutral)	22	Plant auxiliary E-heater control	Under voltage output 230Vac, 50Hz, 2A (AC1) To activate this function see paragraph 11.7.1
DO4	H82	9.1(phase) 9.2 (neutral)	14	Plate heat exchanger resistance (only in the -K version) / Configurable output (in models without antifreeze kit)	Under voltage output 230V ac, 50Hz, 2A (AC1)
DO5	H83	10.1(phase) 10.2 (neutral)	28	Bottom heater (only in the -K version) / Configurable output (in models without antifreeze kit)	Under voltage output 230V ac, 50Hz, 2A (AC1)
DO6	H84	11.1 (phase) 11.2 (neutral)	6	DHW valve control (see paragraph 11.2)	Under voltage output 230V ac, 50Hz, 2A (AC1)
DO7	H85	14.1 (phase) 14.2 (neutral)	25	Double set point control (See paragraph 11.16)	Under voltage output 230V ac, 50Hz, 2A (AC1)
Modbus RTU RS 485	--	4.1 (GNDR) 5.1 (R-) 5.2 (R+)	--	--	Modbus Communication

USER TERMINAL BLOCK

For example Single Phase Unit

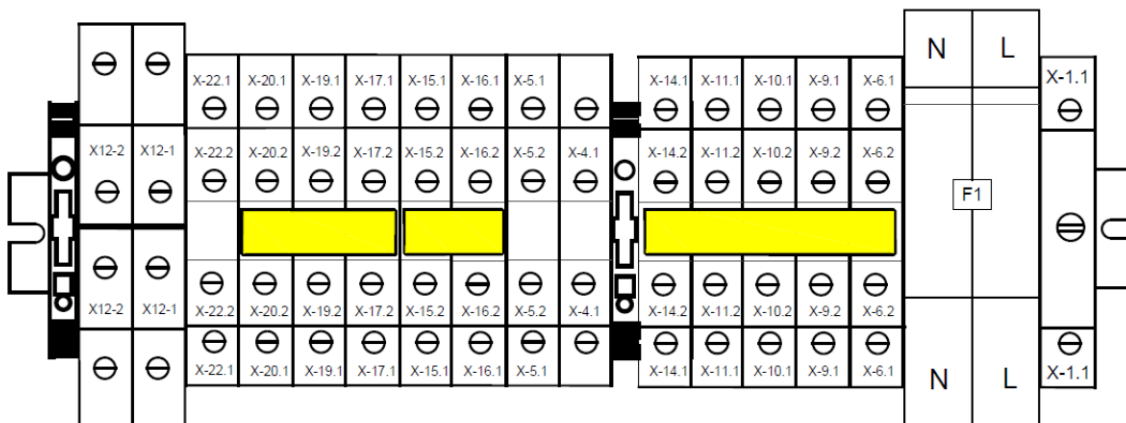

6 DYNAMIC SET-POINT ADJUSTMENT

The controller allows you to change the set-point by adding a value as a function of the outdoor air temperature sensor detection. In this case, you need to change the values of the parameters from **b08** to **b14** according to the indications below (the settings are the installer's responsibility):

Parameters of the controller **PAr->rE->**

- **b08** = dynamic set-point, enabled = 1/ disabled = 0 (in case of use of the climatic compensation by touch-screen remote control, optional, b08 must be disabled)
- **b09** = offset max in cooling mode operation.
- **b10** = offset max in heating mode operation.
- **b11** = Outdoor temperature setting in cooling mode.
- **b12** = Outdoor temperature setting in heating mode.
- **b13** = Outdoor Temperature difference in cooling mode operation.
- **b14** = Outdoor Temperature difference in heating mode operation.

Curve of the set-point variation as a function of the outside temperature:

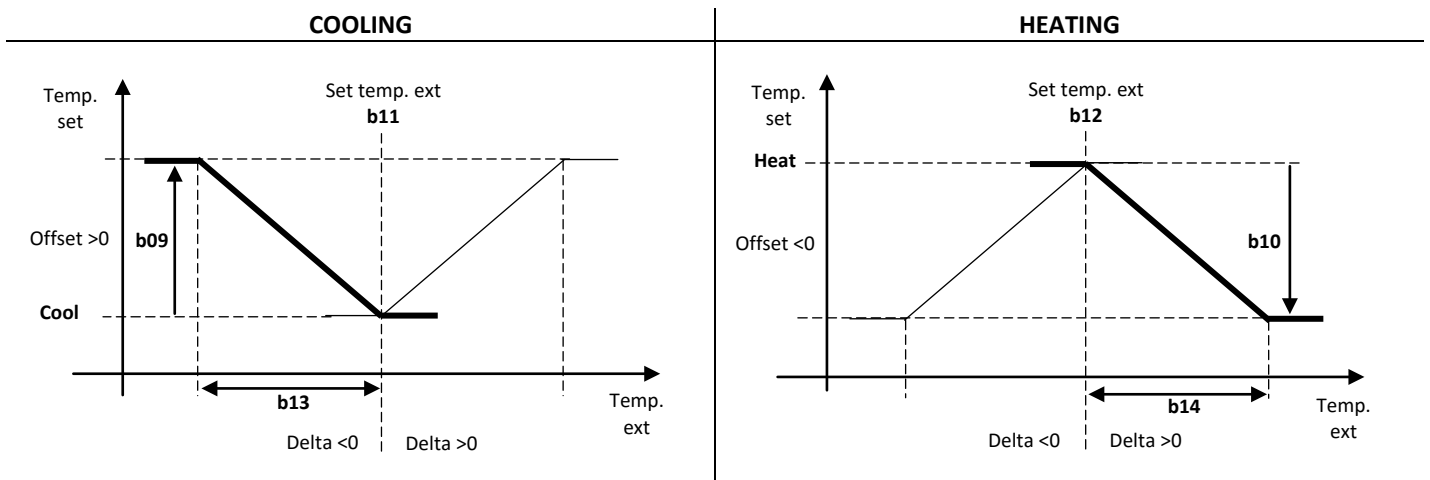

6.1 SETTINGS FOR STANDARD CLIMATE CURVES

HEATING

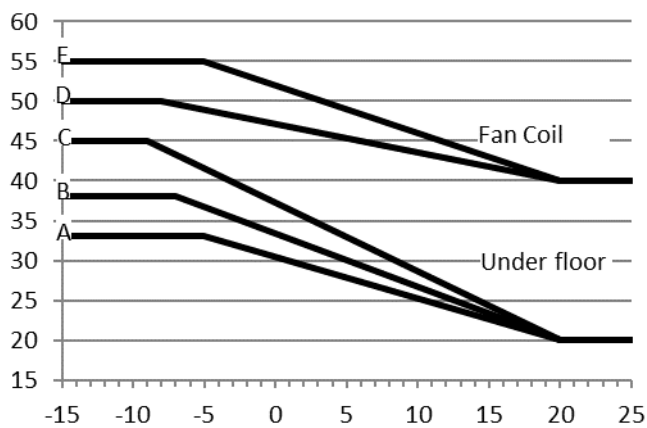

COOLING

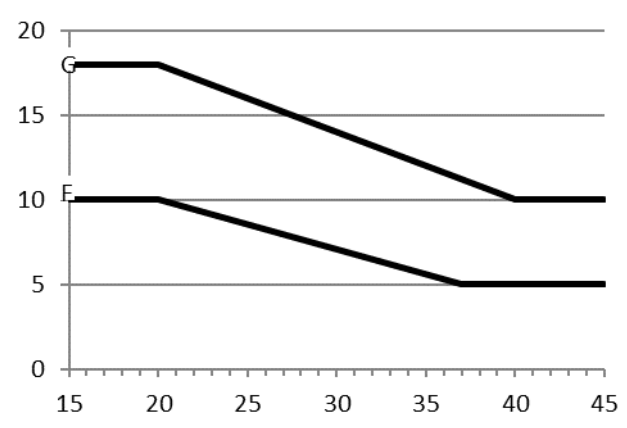

CURVE	Setpoint Heat	Setpoint Cool	b08	B09	b10	B11	b12	B13	b14
A	33°C	--	1	--	-13°C	--	-5°C	--	25°C
B	38°C	--	1	--	-18°C	--	-7°C	--	27°C
C	45°C	--	1	--	-25°C	--	-9°C	--	29°C
D	50°C	--	1	--	-10°C	--	-8°C	--	28°C
E	55°C	--	1	--	-15°C	--	-5°C	--	25°C
F	--	5°C	1	5°C	--	37°C	--	-17°C	--
G	--	10°C	1	8°C	--	40°C	--	-20°C	--

7 SET-POINT ADJUSTMENT FROM 0-10V INPUT

Another type of setting that allows to change the set-point by adding (or subtracting) a value in function of the 0-10V analogue input (if enabled). To enable the function, you must use the following setting **H22=40**, and change the values of the parameter **b15** (range 0-10), taking into account that if **b20=0** input of 0-10V, if **b20=1** ratiometric input type:

- **b20=0** if this input is at 0 volts you will have the actual set point: **set point (Coo/Hea) - b15/2**.
- **b20=0** if the input is at 5 volts the set point will be the set of (Coo/Hea) mode.
- **b20=0** if the input is 10 volts you will have the actual set point: **set point (Coo/Hea) + b15/2**.

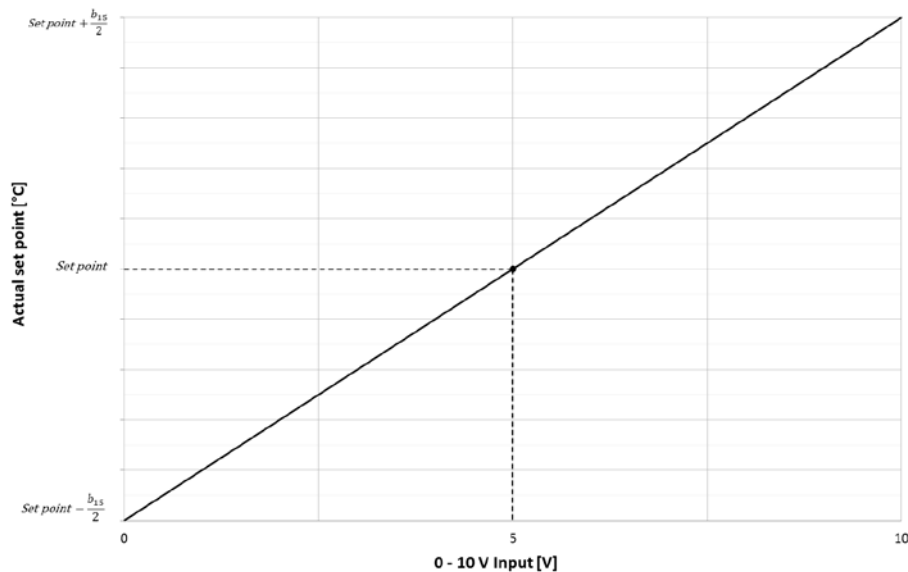

- **b20=1** when the input is at 0%, the actual set point is: **set point (Coo/Hea) - b15/2**.
- **b20=1** when the input is at 50%, the set point will be the set of **(Coo/Hea) mode**.
- **b20=1** if the input is 100%, the actual set point is: **set point (Coo/Hea) + b15/2**.

The 0-10V signal must be applied to the terminals X-22.1 and X-22.2 - (see the wiring diagrams).

Note: In "cooling" mode, considering that the set-point by default is set to be 7°C, the parameter (**b15**) should not assume any value greater than or equal to 6 in order to prevent that the new set-point set from 0-10V input to take values below the threshold of the antifreeze operation which is 4°C.

8 CIRCULATOR

The circulating pump can be set according respecting the following operating modes:

- Thermoregulatory operation
- Thermoregulatory operation with periodic activation
- Continuous operation (default)

The circulator will switch off immediately if:

- Presence of blocking pump alarm including the manual reset alarm of the flow switch;
- The unit is off or in stand-by mode or when it's switched off from remote input, the circulating pump (if is ON) will always turn off after **P02** (default two minute).

The circulator is always running if the antifreeze heaters are activated.

The circulator can be configured with the parameter **P03** in order to operate independently than the compressor or under a thermoregulatory call.

- **P03=0** => Continues operation in heating/cooling modes (Default),
- **P03=1** => Operation under thermoregulatory call

Note: If the automatic reset alarm of the flow switch is ON, the pump is anyway in operation even if the compressor is off.

Contrarily, the circulator remains always in operation if the antifreeze heaters are on or when the hydraulic pump operates in antifreeze mode. The operation in antifreeze mode will start if the water setting temperature decreases below P04 °C (default value 5°C), and it will be disabled if the water setting temperature increases above P04+P05 °C (the default value of P05 is 2,0°C). The adjustment of the circulator is linear (see Paragraph 8.5).

8.1 OPERATION BY MEAN OF THERMOREGULATOR

During this operating mode (**P03=1**), the thermoregulator actuates the pump; after a time delay of 30 seconds from startup of the pump, the compressor also will turn on. However, during the power off status, the pump turns off with a delay time of **P02** minutes after turning off status with thermoregulator call (the turning off status is corresponding to the off status of the compressor).

In the case of activation of the flow switch alarms with automatic reset, the pump remains still in operation even if the compressor is stopped.

If you enable the operation of the unit from the remote "on-off" digital input (see Paragraph 11.5.1) the circulating pump will be activated immediately for a duration of 2 minutes regardless of the on-board controller thermoregulation of the unit (the activation of water recirculation in the plant leads to a correct activation of the thermoregulation).

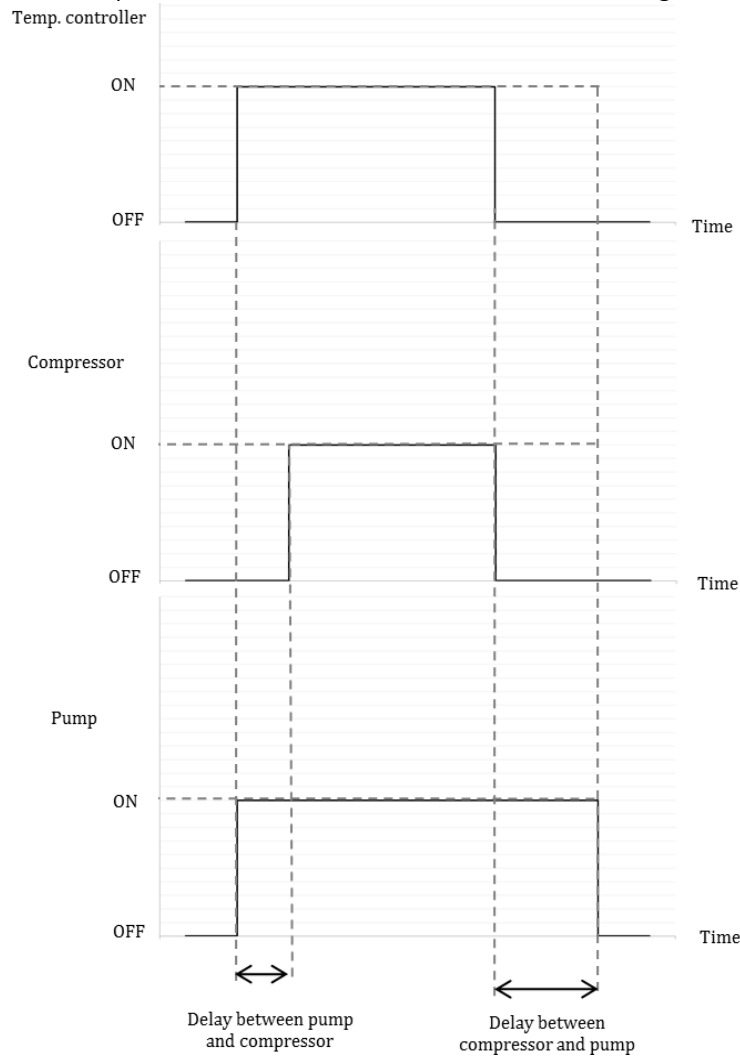

8.2 OPERATION BY THERMOREGULATOR WITH PERIODIC ACTIVATION

The function is disabled if **P17= 0** (default). If the pump is set to operate by thermoregulation call (**P03 = 1**), it will be activated periodically for a time period defined by the parameter **P17** (in seconds) after a counting time set by the parameter **P16** (in minutes), activated when the pump is turned off for satisfied thermoregulation.

In the case of the activation of the flow switch alarm with automatic reset the pump is still operating even if the compressor is off. The periodic function is also interrupted in the case of the intervention of the antifreeze thermo-regulator constraining the operation of the pump.

8.3 OPERATION WITH ACTIVE ELECTRIC HEATER

See paragraph 11.9.

8.4 CONTINUOUS OPERATION

In this operating mode is active if **P03=0** (default), the pump is always running. It turns off only when the unit is in OFF status. The pump is always ON even if automatic reset flow switch alarm is ON and even the compressor is off.

8.5 PROPORTIONAL ADJUSTMENT OF THE PUMP

The pump speed can change as a function of the temperature difference between the water inlet and the water outlet of the heat exchanger, according to the diagram shown below, where:

P07: Maximum speed of the modulating pump (%)=100 (based on the model)

P08: Minimum speed of the modulating pump (%)=0÷100 (based on the model)

P09: set Delta T inlet/outlet water of the heat pump (°C)

P10: Delta modulating pump (°C) = 3°C.

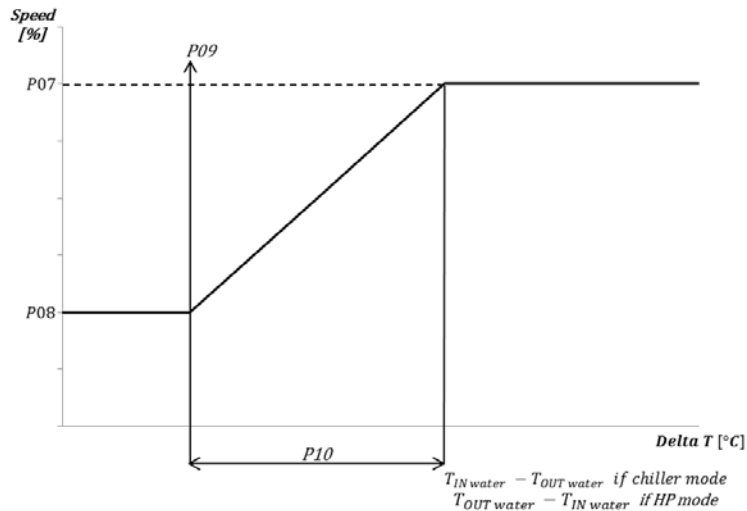

In domestic hot water production mode, the pump will operate at the maximum speed.

Note: If the parameter r33>0, then the circulator can start operations under call also for the activation of the plant resistance and/or sanitary mode operation, see paragraph 11.9.

8.6 PURGING THE SYSTEM

This function allows purging the system using the circulator at the maximum speed.

To enable the function:

- Control in **OFF** mode
- Enter into the parameters PRG→PSS→ PRG → (introduce the Maintainer password)
- Press simultaneously for 3 seconds the buttons **UP** and **DOWN**.

The circulator of the system starts operation at the maximum speed, and after **5 minutes** the circulator will stop to operate.

You can manually exit from purging the system cycle by pressing the **MODE/ESC** button, or by pressing simultaneously the **UP** and **DOWN** buttons for 3 seconds.

During this function the flow switch alarm is deactivated. The maintenance technician must guarantee the water content inside the system.

9 COMPRESSOR CONTROL LOGIC

The restart of compressor is a function of a set point referred to inlet water temperature. It is based on calculation of ΔT_{set} which is the difference between outlet water temperature and inlet water temperatures, detected while the compressor for thermoregulation is turning off.

9.1 Inverter compressor control in cooling mode

- $T_{w,out,set}$ = adjusted setpoint in cooling
- $\Delta T_{,set} = T_{w,out,set} - T_{w,in,set}$
- $b05$ = compressor delta cut-off set= 0,2°C (default)
- $b25$ = delta cut-on compressor set= 2°C

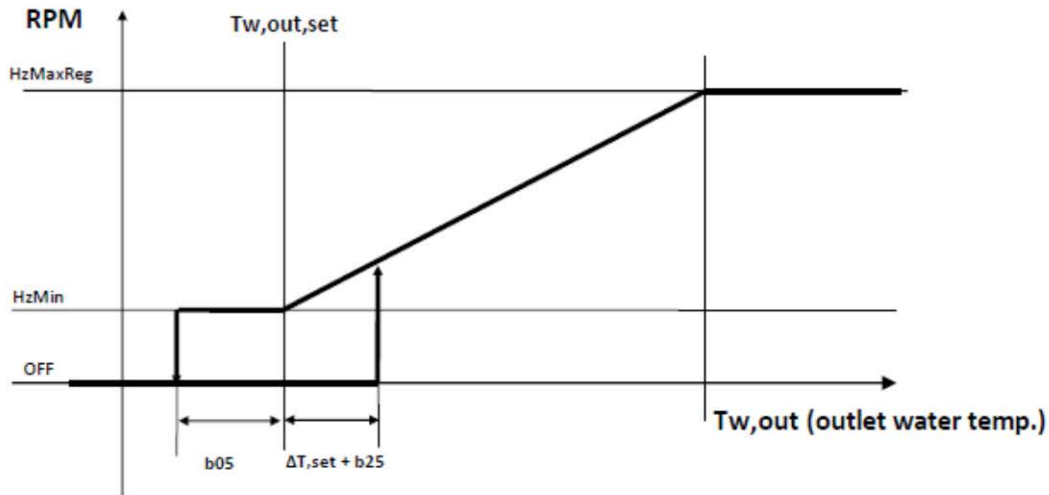

- The compressor shutdown is set by the parameter $b05$: the compressor shutdown when $T_{w,out} < T_{w,out,set} - b05$
- The compressor restart starts when $T_{w,out} > (T_{w,out,set} + \Delta T_{,set} + b25)$

EXCEPTION: if $\Delta T_{,set} > 8^\circ\text{C}$, the compressors restart when the discharge probe temperature is lower than the setpoint 10°C : $T_{w,out} > (T_{w,out,set} + 10^\circ\text{C})$.

9.2 Heating function control

- $T_{w,out,set}$ = setting setpoint in heat mode
- $\Delta T_{,set} = T_{w,out,set} - T_{w,in,set}$
- $b05$ = compressor regulation delta cut-off = 0,2°C (default)
- $b25$ = compressor regulation delta cut-on = 2°C

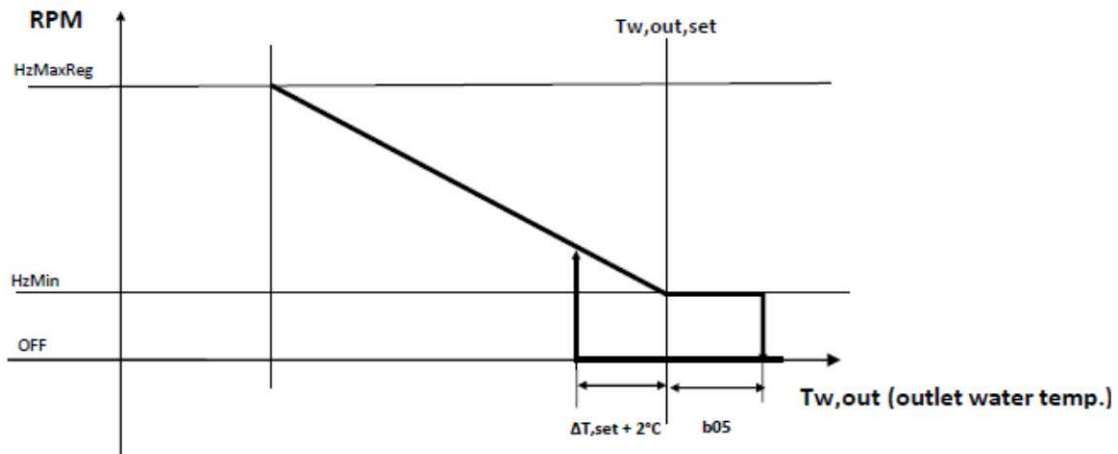

- The compressor shutdown is regulated by parameter $b05$: the compressor shutdown when è regolata dal parametro $b05$ $T_{w,out} > T_{w,out,set} + b05$
- The compressor restart when: $T_{w,out} < (T_{w,out,set} - \Delta T_{set} - b25)$

EXCEPTION: if $\Delta T_{,set} > 8^\circ\text{C}$, the compressors restart when the discharge probe temperature is lower than the setpoint 10°C : $T_{w,out} < (T_{w,out,set} - 10^\circ\text{C})$

10 HEAT DISSIPATION FAN MOTOR CONTROL

The control of the dissipation is a function of the condensing pressure in chiller mode and it is a function of the evaporation pressure in heat pump mode.

The adjustment of the fan speed occurs depending on the compressor operation.

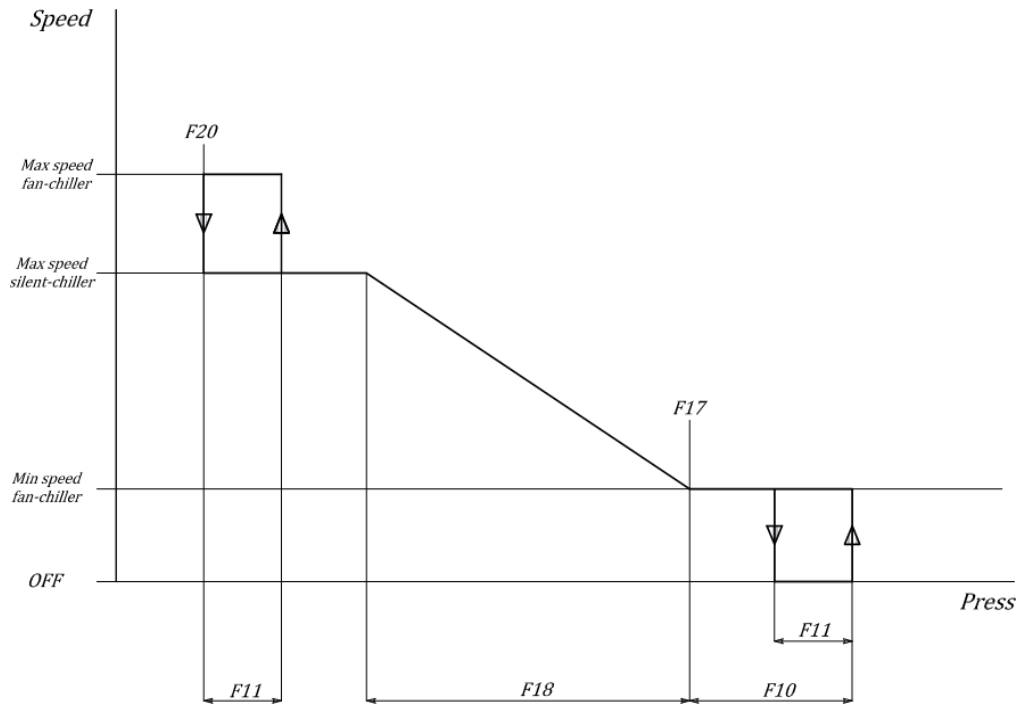

11 CONTROL FUNCTIONS

The functions that can be activated by the on-board unit controller are listed below; note that, these functions are not all selectable at the same time.

Other values different than the default can ensure the proper operation of the unit, in case of doubt about the value that to be set please contact our office.

11.1 ANTIFREEZE PROTECTION ELECTRIC HEATERS (only for -K version)

The water antifreeze electric heaters installed on the outer surfaces of the evaporator's plates start operation even when the unit is off (but under voltage) if the outlet water temperature goes below **r02** °C (default is 4°C) in heating mode or below **r03** °C (default is 4°C) in cooling mode and in shut off condition. The same electric heaters are switched off when the temperature measured by the outlet water sensor exceeds **r02+r06** in heating mode or **r03+r06** in cooling mode and in shut off condition (as default value **r06=2,0°C**). The heating cable placed on the basement of the appliance turns on when the outdoor air temperature decreases below 3°C and the unit starts the defrosting cycle (or if **r19=0** even if the unit is not in defrosting cycle, or in stand-by mode). It will be deactivated if the outdoor temperature exceeds 5°C or the last defrosting cycle is concluded after more than **r19** minutes (default 10 minutes) (with **r19≠0**).

11.2 ACTIVATION OF SANITARY (DOMESTIC) HOT WATER PRODUCTION

To activate the hot sanitary water function, be sure to install a temperature sensor inside the tank and to connect it to the **X17.1-X17.2** terminals (enabled as analog input).

In order to enable this function, you should enter into the page of parameters **PRG→PSS→PRG→** (type the service password) → **PRG→PAr→PRG→CnF**.

See paragraph 13.

I/O Ports - Parameter	Value	Function
H10	0 (default)	Inactive function
	H10=1	Function is active in heating and cooling mode . The remote on-off function doesn't disenable the DHW production.
	H10=2	Function is active in heating and cooling mode . The remote on-off function disenables the DHW production.
	H10=3	Function is active in heating mode . The remote on-off function doesn't disenable the DHW production.
	H10=4	Active function in heating mode . The remote on-off function disenables the DHW production.
	H10=5	Active function in cooling mode . The remote on-off function doesn't disenable the DHW production.
	H10=6	Active function in cooling mode . The remote on-off function disenables the DHW production.
ST6 activable via H17	H17=6	Enablement of the DHW temperature sensor.
DO7 activable via H84	H84=6	DHW valve command.

If the DHW temperature is below than the set point value (fixed at 48°C by default and adjustable by entering the **PRG->Set->SAN** menu), the unit activates the sanitary valve and the compressor is set at the maximum frequency starting the modulation at one degree before the set value and it stops at one degree after the set value. Once reached the set point value, the valve switches to the stand-by mode and the compressor works normally.

While shifting from user's to domestic hot (sanitary) water, the operating sensor changes from "outlet water sensor" to "sanitary tank sensor". While shifting from the winter operating mode to the sanitary operating mode, the compressor does not switch off, and reaches the maximum established frequency that to be controlled; on the other hand, while shifting from the summer operating mode to the sanitary operating mode, the compressor is switched off to wait for the safety timing.

The defrosting during winter operation mode is always performed on the user side, never on the sanitary water tank.

Note:

- If **H10 = 1/3/5**. Turning off the unit remotely (remote switch onoff see paragraph 11.5.1), or via the on-board controller, or with the remote control panel does not affect the sanitary operating mode. The unit starts in sanitary mode as setting priority when it's powered on. The on board unit display shows the temperature measured by the sensor placed inside the sanitary water tank. Once the sanitary cycle is completed, the display returns to show the temperature of the outlet water sensor.

If the remote ON-OFF digital input (onoff-onoff terminals) is open, with the enabling of the domestic hot water production (**H10=1** and **H20=6**), the display on-board unit shows the item "SAN". Once the sanitary cycle is concluded, the display returns to show the code "E00" indicating that the remote ON-OFF contact is open.

- If **H10 = 2/4/6**, the remote on-off function disables the production of domestic hot water and the operations of the heat pump in heating and cooling on plant side.

11.2.1 Sensor memorization in heating mode

In the case of commutation from water users to the sanitary water, the temperature sensor changes from a "water outlet temperature sensor" to a "water tank temperature sensor". For such reason, in heating mode, the last value read by the outlet temperature sensor of the heat pump will be memorized before changing to sanitary mode.

When the sanitary thermoregulation is reached, the reference temperature on the plant side will take the value which is previously memorized.

The memory function will be interrupted:

- When the temperature detected by the sensor becomes lower than the memorized value;
- Or after duration equal to **b06** seconds (default 45 seconds).

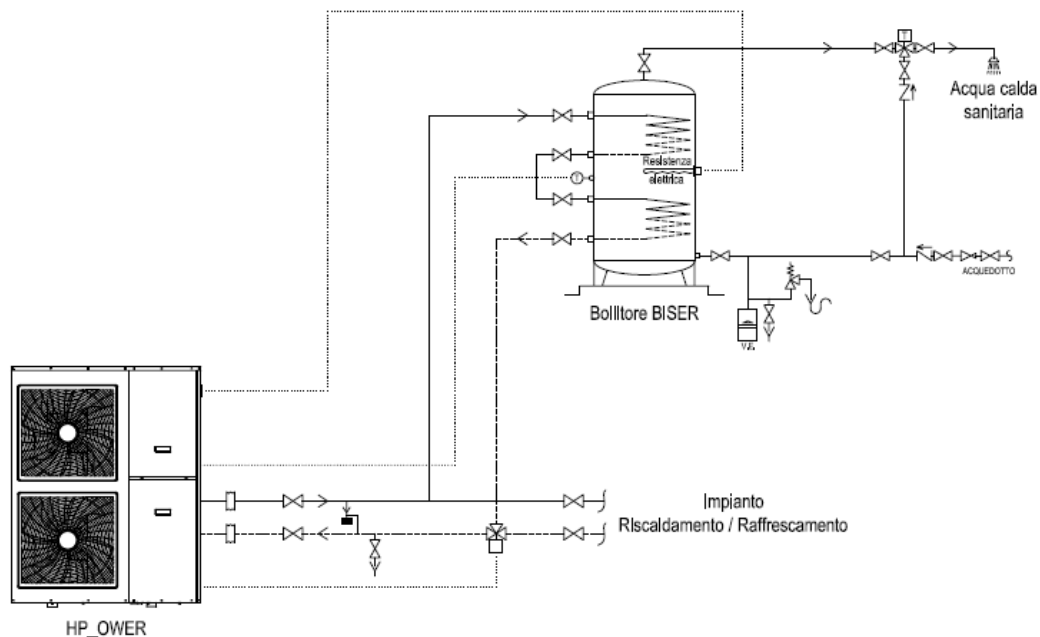

TATO

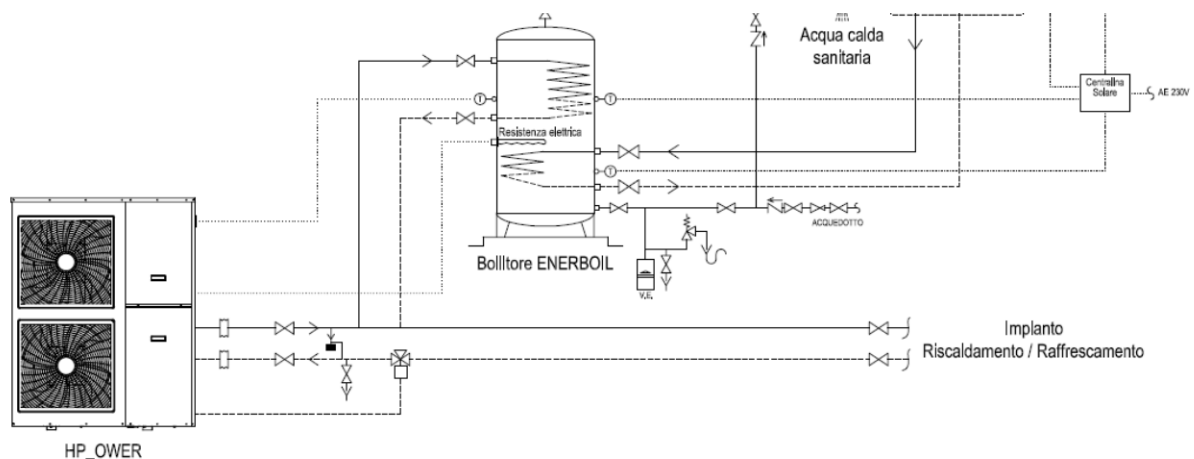

11.3 HEATING MODE ON SANITARY ACCUMULATION

If **H130=1**, the appliance exploits the accumulation tank for sanitary hot water also for heating the plant side. In these conditions, the command relay of the sanitary valve will be also energized during heating operation and not only in sanitary mode. During defrost cycle and in cooling mode the valve will be de-energized. When **H130=1**, the sanitary auxiliary electric heater can be enabled also to act as a plant auxiliary electric heater: to this purpose you should set **r10=1** and **r15=2** (for further settings of the parameter **r15** please see Paragraph 11.7.3); also no digital output has to be set for the auxiliary electric heater for the plant.

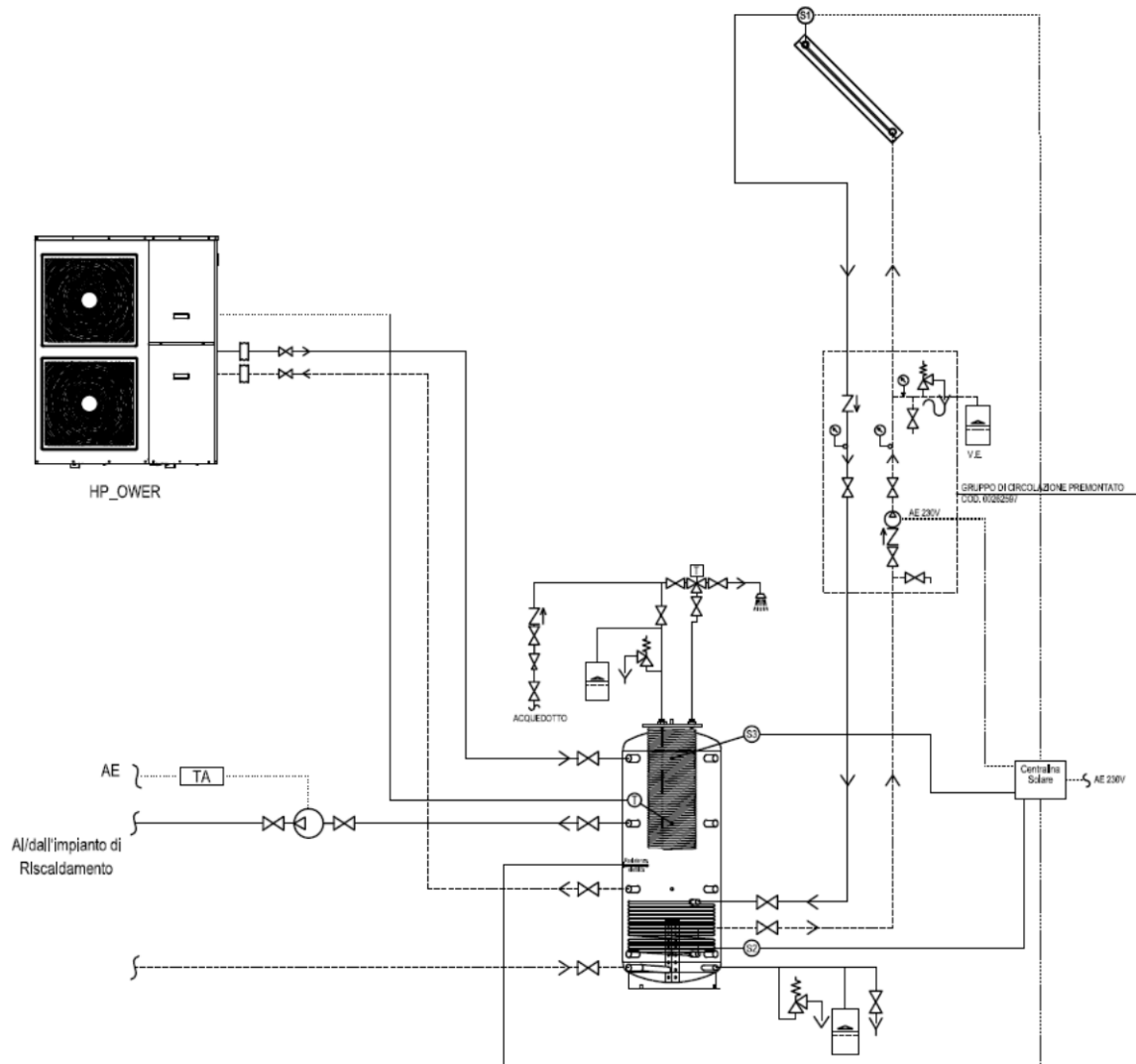

11.4 MODE ON SANITARY ACCUMULATION

During DHW production, if the heat pump flow probe detects a temperature higher than 60°C, the DHW valve output is de-energised (DO6), and the value of the DHW probe at this time is recorded (Tsan,set).
 -if the operation is San or Cool+San the compressor is stopped.
 -If the operation is Heat+San, the system evaluates for b06 seconds whether there is a demand for heating from the system. If the system requires it, the compressor continues to work on the system, otherwise it is switched off.
 -If the DHW resistor is present (e.g. DO3, H81=26), r15 = 0 or 1 and r24=2 or 3 it is activated until the DHW setpoint detected by the DHW probe is met (and any offset).
 The compressor restarts when the flow temperature of the heat pump falls below 60°C again and the temperature measured by the DHW probe is lower than T_{san,set} - 4°C.

11.5 REMOTE FUNCTIONS

The terminal block provides the digital inputs to control the unit via external consent.

11.5.1 ON/OFF

The ON/OFF function is enabled by default via the digital input "ID3" (X15.1/X15.2 terminals).

Remove the bridge of the terminal block then the unit will be placed in stand-by mode (in such status the display of the on-board unit controller will show the "E00" code). When the contact is closed, the machine exits from standby mode and the circulation pump will be activated for 2 minutes.

Enabled function by default (H47=2).

I/O Ports	Function
ID3 Digital Input	Enablement of the remote On/Off function

If the sanitary mode is active and the H10 parameter is set as:

H10 = 1, the remote on-off function has no effect on the production of domestic hot water, it turns off only the heating/cooling operation of the heat pump on plant side (in such case the on-board unit control display shows the voice "SAN").

H10 = 2, the on-off remote function turns off the production of domestic hot water and also the heating/cooling operation of the heat pump on plant side.

If off-off occurs remotely during defrosting, the heat pump ends defrosting and then positions itself in remote off mode.

11.5.2 Summer/Winter mode commutation

This function is set by default via the digital input ID2 (X16.1/X16.2 terminals).

You can manage remotely the operating mode in heating or in cooling of the heat pump.

In order to enable this function, you should enter into parameters PRG→PSS→PRG→ (insert the service password)→PRG→Par→PRG→CnF.

I/O Ports - Parameter	Value	Function
ID2 activable via H46	H46=3	Open Contact → Heat pump in cooling mode. Closed Contact → The heat pump in heating mode.

11.5.3 Sanitary mode call from digital input

The sanitary function can be used instead of the double setpoint management.

If the domestic hot water mode operation is enabled and the parameter used to replace the temperature sensor, the activation of the previous mode can be performed through the opening/closing of a digital input of the unit. This function is recommended in case of utilization of two or more i-HWAK units in cascade configuration and linked through a hydronic connection to the same accumulation tank of domestic hot water; in this way the activation of the domestic hot water function will be selected through the sensor of the accumulation tank that is connected to the first unit, while the other units will be automatically enabled by a digital consent.

The system goes in domestic hot water mode when the digital input closes and quits this mode when the digital input opens.

In order to enable this function, you should enter into the parameters' page PRG→PSS→PRG→ (insert the service password) → PRG→Par→PRG→CnF.

I/O Ports - Parameter	Value	Function
H76	H76=1	Digital inputs polarities
ID9 activable via H53	H53=28	Closed contact → Heat pump in DHW mode. Open contact → Heat pump in heating or cooling mode of the environment (plant system mode).

- In the case where a digital input is configured for DHW function call (instead of the sensor), the heat pump will be placed in DHW mode when the digital input is closed and exits from the DHW production when the digital input is open.
- *The SAN setpoint of the heat pump is not taken in consideration, the management of such setpoint is entrusted to the designer of the plant, who must take into account the domestic hot water protection and the configuration of the whole system.*

Note: You can reverse the polarity of the digital input, placing the maintainer (service) parameter to be H76 = 0.



11.6 REMOTE SENSOR FOR THE WATER TEMPERATURE OF THE PLANT CIRCUIT

In some systems' configurations (example: heat pump in parallel with a boiler on the same hydronic circuit and with a diverter valve of exclusion) it could be necessary to enable a plant temperature sensor to allow the on-board controller to correctly process the management.

In order to enable this function, please enter into the page of parameters PRG→PSS→PRG→ (insert the maintainer password) → PRG→Par→PRG→CnF.

I/O Ports - Parameter	Value	Description
"ST7" analog input activable via H18	H18=41	To enable plant remote temperature sensor

The plant circuit remote sensor adjusts the heat pump temperature only during the startup period of the compressor(s), the shutdown is managed by the outlet temperature sensor of the heat pump. For more explanation, herein below is reported an illustrating table concerning the operation process of the system:

Operating mode	Heat pump enablement calling
 Heating	Temperature measured by outlet sensor of the heat pump < setpoint Hea – 0.5°C and Temperature measured by plant circuit remote sensor < water setpoint Hea - b22
 Cooling	Temperature measured by the outlet sensor of the heat pump > setpoint Coo + 0.5°C and Temperature measured by plant circuit remote sensor > setpoint Coo + b22

Note: b22=5°C. See paragraph 13.

11.7 AUXILIARY ELECTRIC HEATER

In some configurations of some plant systems, it could be necessary the use an auxiliary electric heater for the system and/or DHW sides.

To define the mode of using of the auxiliary electric heaters for plant system and DHW side, you must set the parameter “r24” as below.

- **r24=0** Auxiliary electric heaters not active;
- **r24=1** Utilization only of the auxiliary electric heater of the plant side;
- **r24=2** Utilization only of the auxiliary DHW electric heater;
- **r24=3** Utilization of both auxiliary electric heaters of plant side and of domestic (sanitary) hot water production.

11.7.1 Plant circuit electric heater

If the regulating temperature remains below the **water setpoint in heating (Hea) - 0.5°C** for a period of time equal to **r12**, the auxiliary electric heater will start operation according to the in joint or in substitution operation of the unit, see Paragraph 11.12. The electric heater will stop operation after reaching the setpoint (taking into account of an eventual offset which could be set with the parameters **r29** or **r30**).

If the regulating temperature remains less than **water setpoint - r11(°C)** and the unit is blocked because of an error-alarm, the electric heater will be activated. Then it will stop operation when the error-alarm is resolved.

In order to enable this function, you should enter into the page of parameters as follow **PRG→PSS→PRG →** (insert the service password) **→ PRG → PAr → PRG → CnF / Fro.**

I/O Ports - Parameter	Value	Function
r10	1	Enablement of the function
r11	0.5°C (default)	Delta of the auxiliary electric heaters in heating operation
r12	10 minutes (default)	Activation delay of auxiliary heating element of the plant side
r24	r24=1 or 3	Type of utilization of the electric heater
“DO3” active by default	H81=22	Plant auxiliary electric heater

11.7.2 Auxiliary electric heater of the plant in defrost cycle

During the **defrosting cycle**, see paragraph 11.13.2 (by setting **r21=1** in addition to **r10=1** and **r24=1 or 3**) the electric heater of the plant system side will start to operate if required (when the regulating temperature is lower than the **water setpoint - r11 (°C)**), without waiting for the duration defined by **r12**.

In order to enable this function, please enter into the page of parameters as follow, press **PRG→PSS→PRG→** (then insert the maintainer password) **→ PRG → PAr → PRG → Fro.**

11.7.3 Electric heater of sanitary water production

This function can be activated instead of using the plant electric heater.

It is an additional heating energy source for the sanitary water tank when the compressor is not able to reach the set temperature within a reasonable duration of time.

If the production of sanitary hot water remains for a period of time greater than **r16** (minutes) and the unit gets blocked due to an alarm intervention, the electric heater will be enabled. It turns off when the unit concludes the sanitary water production (taking into account also of any offset adjusted by the parameters **r31** as described in the Paragraph 11.12.1.)

In order to enable this function, please enter into the page of parameters **PRG→PSS→PRG →** (insert the service password) **→ PRG → PAr → PRG → Fro.**

I/O Ports - Parameter	Value	Function
r15	r15=1	Enablement of the function
r16	r16=15 minutes (default)	Activation delay of the auxiliary DHW heating element
r24	r24=2/3	Type of electric heaters utilization
“DO3” active by default	H81=26	Plant side auxiliary electric heater

Note: The DHW function should be active (see paragraph 11.2)

11.7.4 A single auxiliary electric heater for both plant system/dhw production

By configuring the auxiliary electric heater for DHW production, you can use such declared electric heater, also as an auxiliary electric heater for the plant system by selecting the following setting **r15=2** and **r24=3**.

When the auxiliary electric heater of the plant system is activated, the declared DHW electric heater will be activated allowing you to get one auxiliary electric heater for DHW production, plant system and defrosting operation.

In order to enable the function, you should enter into the page of parameters as follow: **PRG→PSS→PRG →** (then insert the service password) **→ PRG → PAr → PRG → Fro.**

11.8 Selection mode of auxiliary electric heaters

It is possible to set the order priority of the activation of the of the plant system and of the DHW production sides' auxiliary electric heaters as in the below configurations:

r14=0 (default), the electric heaters will be activated simultaneously if they are present;

r14=1, the electric heaters will be activated one excludes the other:

r20=0, the priority is for the plant (the sanitary heater will operate only if the thermoregulation for the heater of plant side is accomplished);

r20=1, the priority is for the sanitary (the electric heater of the plant system side will operate only if the thermoregulation of the sanitary heater is accomplished).

11.9 Management of the circulator with active electric heater

It is possible to activate the circulator of the heat pump when the plant system and/or the DHW auxiliary electric heaters are active in the absence of compressors operations (for substitution, for alarm or for integration in band II or III).

For enabling this function, you should enter into the parameters as follow: press **PRG→PSS→PRG →** (then insert the maintainer password) **→ PRG → PAr → PRG → Fro:**

– **r33 = 0:** The circulator of the heat pump will be activated upon request of the compressors or by the boiler.

– **r33 = 1:** The circulator of the heat pump will be activated if the plant circuit electric heater is active.

– **r33 = 2:** The circulator of the heat pump will be activated if the DHW electric heater is active.

– **r33 = 3:** The circulator of the heat pump will be activated if the plant system electric heater or if the DHW electric heater is active.

The circulator will stop operation after the post-pumping (**P02**).

11.10Boiler enablement

It is an additional energy source which enables the boiler in integration or in substitution of the heat pump.

To activate this function, you should enter into the parameters as follow: press **PRG→PSS→PRG→**(then insert the maintenance password)**→PRG→PAr→PRG→CnF/Fro:**

Definition of the type of using of the auxiliary systems by setting the parameter **r23:**

- **r23=0** (default) boiler not used (priority of intervention is for electric heaters);
- **r23=1** boiler used just on plant side (priority of intervention is for electric heaters);
- **r23=2** boiler used just for DHW hot water (priority of intervention is for electric heaters);
- **r23=3** (default) boiler used for both DHW hot water and plant sides (priority of intervention is for electric heaters);
- **r23=4** boiler used only for plant side with priority (no intervention priority for electric heaters);
- **r23=5** boiler used only for DHW hot water with priority (no intervention priority for electric heaters);
- **r23=6** boiler used on both DHW and plant sides with priority (no intervention priority for electric heaters);

Settings of the parameter **r32** for boiler equipment:

- **r32 = 0:** boiler without a circulating pump with thermoregulation to be performed by the heat pump unit.
- **r32 = 1:** boiler equipped with independent circulating pump with thermoregulation to be performed by the heat pump unit.
- **r32 = 2:** boiler without circulating pump with independent thermoregulation.
- **r32 = 3:** boiler equipped with a circulating pump with independent thermoregulation.

I/O Ports - Parameter	Value	Function
r10	1	Activation of the plant auxiliary electric heater
r12	10 minutes(default)	Activation delay of the plant auxiliary electric heater
r15	1	Activation of the DHW electric heater
r16	10 minutes (default)	Activation delay of the auxiliary DHW electric heater
r23	1÷6	Boiler's type utilization
r32	1÷3	Boiler endowment
"DO7" activable via H85	H85=29	Activation of the boiler

11.11 Activation of auxiliary electric heaters and boiler during the joint and in substitution operation to the compressor of the heat pump

The available auxiliary systems for the joint operation or substitution operation are as below:

- Boiler
- Plant auxiliary electric heater
- DHW (Sanitary) auxiliary electric heater

Considering the heating and sanitary mode of operation, you have 4 types of operation:

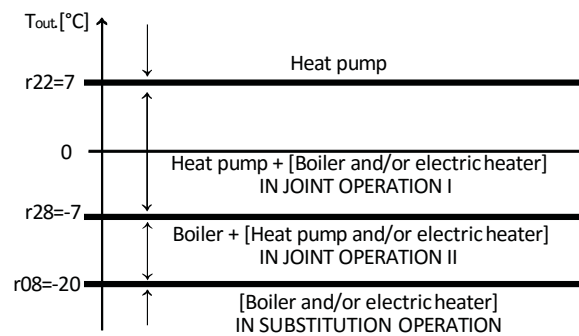

When changing the values of the parameters **r22**, **r28**, **r08**, you have to respect the following condition: **r22 ≥ r28 ≥ r08**.

You can remove the “in joint operation I” zone just by putting **r22=r28**; you can also remove the “in joint operation II” zone by putting **r28=r08**; and hence you can remove both “in joint operations I and II” zones when you use the same setting for the three parameters **r22= r28=r08**.

11.11.1 Operation in heat pump mode

Normal operation of the heat pump in which the electric heaters and-or the boiler will be activated only if the heat pump goes into error-alarm.

11.11.2 In joint operation (Zone I)

If the outdoor air temperature is included between **r22** and **r28**, the compressor operates in synergy with the auxiliary electric heaters during winter and domestic hot water mode.

In this operation zone, the heat pump will start at the beginning and then the plant side auxiliary electric heaters will operate after a period of time given by **r12** (in minutes) and after **r16** (in minutes) the DHW auxiliary electric heaters will start operation.

The activation priorities are defined by the following parameters **r14**, **r20**, **r23** and **r24**.

The operation becomes **normal** if the temperature increases above the value given by **r22 + 1,0°C**.

Note: In the joint operation, the temperature of the boiler is controlled by the water temperature remote sensor of the plant circuit (if enabled), particularly if the temperature measured by the remote sensor is less than the setpoint **Hea**, the boiler will be activated, and then will be deactivated when the measured temperature by the remote sensor is greater than setpoint **Hea**. The heat pump follows the activation logic described in paragraph 11.6.

The boiler will be managed by the outlet temperature sensor of the heat pump if the water plant circuit remote sensor is not enabled.

11.11.3 In joint operation (Zone II)

If the outdoor air temperature is included between **r28** and **r08**, the compressor will operate in synergy with the auxiliary electric heaters.

In this operation zone, the devices will start operation in the following working order: at first the boiler will start the operation, then the heat pump and the plant circuit auxiliary electric heaters will start operation after a period of time given by **r12** (in minutes) and after **r16** (in minutes) the DHW auxiliary electric heaters will start operation.

The activation priorities are defined by the following parameters **r14**, **r20**, **r23** and **r24**.

The operation becomes **normal** if the temperature increases above the value of **r28+1,0°C**.

Note: In the “joint operation”, the temperature of the boiler is adjusted by the water temperature remote sensor of the plant circuit (if enabled), particularly if the temperature that measured by this remote sensor is less than the setpoint **Hea**, the boiler will be activated, and then will be deactivated when the measured temperature by the remote sensor is greater than setpoint **Hea**. The heat pump follows the activation logic described in paragraph 11.6.

The boiler shall be managed by the outlet temp. sensor of the heat pump if the water plant circuit remote sensor is not active.

11.11.4 In substitution operation

If the outdoor air temperature decreases below **r08**, the compressor operation will be inhibited.

If the auxiliary system is composed of the plant circuit and/or the DHW electric heaters, they will be activated in substitution to the compressor with a duration defined by **r12** (minutes) for the plant circuit side and by **r16** (minutes) for the domestic hot water side.

During the substitution operation, instead it is not necessary to enable the auxiliary electric heaters with the parameter **r10** or **r15**, because the auxiliary electric heaters operate in substitution (and not as auxiliary heating systems) to the heat pump (therefore it is enough to select the type of utilization of the auxiliary electric heaters by setting only the parameter **r24**).

If the auxiliary system is a boiler with its proper circulator (**r32 = 1** or **3**).

The circulator of the heat pump will be off, the boiler will be enabled after **P01** (default 30 seconds).

Note: When the defrosting protection occurs on the water side, the utilization pump will be activated (or remains on).

If the in substitution auxiliary system is a boiler with its proper temperature control (**r32 = 2** or **3**).

The boiler will be enabled independently than thermoregulation of the heat pump.

If the in substitution auxiliary system is a boiler without circulator (**r32 = 0 or 2**).

The circulator of the heat pump will be active when the boiler is enabled.

The compressor will be enabled again if the temperature increases above the value of **r08+ r09** (°C) (by default r09=1,0°C)

11.12 OPERATION ZONE - ACTIVATION OF THE AUXILIARY ELECTRIC HEATER AND BOILER (Plant circuit water temperature sensor is not enabled)

The possible configurations of the parameters related to auxiliary heaters are listed below in the tables 1, 2, 3 and 4, that are divided by zone of operation (the columns of the items "MODE" and "rxx" parameters indicate the operation mode and the possible values of the parameters for allowing the auxiliary electric heaters to act according to a predefined order of intervention, when the unit is running in a certain type of operation; several modes and values of the parameters can be alternatively selected and they are reported in the same cell separated by the symbol "/").

TABLE 1. NORMAL OPERATION IN HEAT PUMP MODE									
N°	ORDER OF INTERVENTION OF HEATING ELEMENTS (when the set-point is not achieved and the unit is in alarm condition)	MODE	OPERATION	r10	r15	r12	r16	r23	r24
1	1) Auxiliary electric heater of plant	HEAT / HEAT+SAN	HEAT	1	0/1/2	/	/	0/2/5	1/3
2	1) Boiler	HEAT / HEAT+SAN	HEAT	0/1	0/1/2	/	/	1/3/4/6	0/2
3	1) Auxiliary electric heater of plant 2) After r12 minutes, Boiler	HEAT / HEAT+SAN	HEAT	1	0/1/2	Set up of minutes	/	1/3	1/3
4	1) Boiler 2) After r12 minutes, auxiliary electric heater of plant	HEAT / HEAT+SAN	HEAT	1	0/1/2	Set up of minutes	/	4/6	1/3
5	1) Auxiliary electric heater of sanitary	HEAT+SAN	SANITARY	0/1	1	/	/	0/1/4	2/3
6	1) Boiler	HEAT+SAN/ COOL+SAN	SANITARY	0/1	0/1/2	/	/	2/3/5/6	0/1
7	1) Auxiliary electric heater of sanitary 2) After r15 minutes, boiler	HEAT+SAN	SANITARY	0/1	1	/	Set up of minutes	2/3	2/3
8	1) Boiler 2) After r15 minutes, auxiliary electric heater of sanitary	HEAT+SAN	SANITARY	0/1	1	/	Set up of minutes	5/6	2/3
9	1) Auxiliary electric heater of Plant/sanitary	HEAT / HEAT+SAN	IN HEAT OR IN SANITARY	1	1	/	/	0	3
10	1) Boiler	HEAT / HEAT+SAN	IN HEAT OR IN SANITARY	0/1	0/1/2	/	/	3/6	0
11	1) Auxiliary electric heater of plant/sanitary 2) After r12 minutes, Boiler	HEAT / HEAT+SAN	IN HEAT OR IN SANITARY	1	1	Set up of minutes	Set up of minutes	3	3
12	1) Boiler 2) After r12 minutes, auxiliary electric heater of plant/sanitary	HEAT / HEAT+SAN	IN HEAT OR IN SANITARY	1	1	Set up of minutes	Set up of minutes	6	3

TABLE 2. JOINT OPERATION, ZONE 1									
N°	ORDER OF INTERVENTION OF HEATING SYSTEMS (when the set-point is not achieved)	MODE	OPERATION	r10	r15	r12	r16	r23	r24
1	1) Heat pump 2) After r12 minutes, auxiliary electric heater of plant	HEAT / HEAT+SAN	HEAT	1	0/1/2	Set up of minutes	/	0/2/5	1/3
2	1) Heat pump 2) After r12 minutes, boiler	HEAT / HEAT+SAN	HEAT	0/1	0/1/2	Set up of minutes	/	1/3/4/6	0/2
3	1) Heat pump 2) After r12 minutes, auxiliary electric heater of plant 3) After r12 minutes later, boiler	HEAT / HEAT+SAN	HEAT	1	0/1/2	Set up of minutes	/	1/3	1/3
4	1) Heat pump 2) After r12 minutes, boiler 3) After r12 minutes later, auxiliary	HEAT / HEAT+SAN	HEAT	1	0/1/2	Set up of minutes	/	4/6	1/3

TABLE 2. JOINT OPERATION, ZONE 1									
N°	ORDER OF INTERVENTION OF HEATING SYSTEMS (when the set-point is not achieved)	MODE	OPERATION	r10	r15	r12	r16	r23	r24
	electric heater of plant								
5	1) Heat pump 2) After r15 minutes, auxiliary electric heater of sanitary	HEAT+SAN	SANITARY	0/1	1	/	Set up of minutes	0/1/4	2/3
6	1) Heat pump 2) After r15 minutes, boiler	HEAT+SAN	SANITARY	0/1	0/1/2	/	Set up of minutes	2/3/5/6	0/1
7	1) Heat pump 2) After r15 minutes, auxiliary electric heater of sanitary 3) After r15 minutes later, boiler	HEAT+SAN	SANITARY	0/1	1	/	Set up of minutes	2/3	2/3
8	1) Heat pump 2) After r15 minutes, boiler 3) After r15 minutes later, auxiliary electric heater of sanitary	HEAT+SAN	SANITARY	0/1	1	/	Set up of minutes	5/6	2/3
9	1) Heat pump 2) After r12 minutes, auxiliary electric heater of plant/sanitary	HEAT / HEAT+SAN	HEAT OR IN SANITARY	1	1	Set up of minutes	Set up of minutes	0	3
10	1) Heat pump 2) After r12 minutes, boiler	HEAT / HEAT+SAN	IN HEAT OR IN SANITARY	0/1	0/1/2	Set up of minutes	Set up of minutes	3/6	0
11	1) Heat pump 2) After r12 minutes, auxiliary electric heater of plant/sanitary 3) After r12 minutes later, boiler	HEAT / HEAT+SAN	IN HEAT OR IN SANITARY	1	1	Set up of minutes	Set up of minutes	3	3
12	1) Heat pump 2) After r12 minutes, boiler 3) After r12 minutes later, auxiliary electric heater of plant/sanitary	HEAT / HEAT+SAN	IN HEAT OR IN SANITARY	1	1	Set up of minutes	Set up of minutes	6	3

TABLE 3. JOINT OPERATION, ZONE 2									
N°	ORDER OF INTERVENTION OF HEATING ELEMENTS (when the set-point is not achieved)	MODE	OPERATION	r10	r15	r12	r16	r23	r24
1	1) Boiler 2) After r12 minutes, heat pump	HEAT / HEAT+SAN	HEAT	0/1	0/1/2	Set up of minutes	/	1/3/4/6	0/2
2	1) Boiler 2) After r12 minutes, auxiliary electric heater of plant 3) After r12 minutes later, heat pump	HEAT / HEAT+SAN	HEAT	1	0/1/2	Set up of minutes	/	1/3	1/3
3	1) Boiler 2) After r12 minutes, heat pump 3) After r12 minutes later, auxiliary electric heater of plant	HEAT / HEAT+SAN	HEAT	1	0/1/2	Set up of minutes	/	4/6	1/3
4	1) Auxiliary electric heater of plant 2) After r12 minutes, heat pump	HEAT / HEAT+SAN	HEAT	1	0/1/2	Set up of minutes	/	0/2/5	1/3
5	1) Boiler 2) After r15 minutes, heat pump	HEAT+SAN	SANITARY	0/1	0/1/2	/	Set up of minutes	2/3/5/6	0/1
6	1) Boiler 2) After r15 minutes, auxiliary electric heater of sanitary 3) After r15 minutes later, heat pump	HEAT+SAN	SANITARY	0/1	1	/	Set up of minutes	2/3	2/3
7	1) Boiler 2) After r15 minutes, heat pump 3) After r15 minutes later, auxiliary electric heater of sanitary	HEAT+SAN	SANITARY	0/1	1	/	Set up of minutes	5/6	2/3
8	1) Auxiliary electric heater of sanitary 2) After r15 minutes, heat pump	HEAT+SAN/	SANITARY	0/1	1	/	Set up of minutes	0/1/4	2/3
9	1) Boiler 2) After r12 minutes, heat pump	HEAT / HEAT+SAN	IN HEAT OR IN SANITARY	1	1	Set up of minutes	Set up of minutes	3/6	0
10	1) Boiler	HEAT /	IN HEAT OR IN	1	1	Set up of	Set up of	3	3

	2) After r12 minutes, auxiliary electric heater of plant/sanitary 3) After r12 minutes later, heat pump	HEAT+SAN	SANITARY			minutes	minutes		
11	1) Boiler 2) After r12 minutes, heat pump 3) After r12 minutes later, auxiliary electric heater of plant/sanitary	HEAT / HEAT+SAN	IN HEAT OR IN SANITARY	1	1	Set up of minutes	Set up of minutes	6	3
12	1) Auxiliary electric heater of plant/sanitary 2) After r12 minutes, heat pump	HEAT / HEAT+SAN	IN HEAT OR IN SANITARY	1	1	Set up of minutes	Set up of minutes	0	3

TABLE 4. SUBSTITUTION OPERATION

N°	ORDER OF INTERVENTION OF HEATING SYSTEMS (when the set-point is not achieved)	MODE	OPERATION	r10	r15	r12	r16	r23	r24
1	1) Boiler 2) After r12 minutes, auxiliary electric heater of plant	HEAT / HEAT+SAN	HEAT	0/1	0/1/2	Set up of minutes	/	4/6	1/3
2	1) Auxiliary electric heater of plant 2) After r12 minutes, boiler	HEAT / HEAT+SAN	HEAT	0/1	0/1/2	Set up of minutes	/	1/3	1/3
3	1) Boiler 2) After r12 minutes, Auxiliary electric heater of sanitary	HEAT+SAN	SANITARY	0/1	0/1/2	/	Set up of minutes	5/6	2/3
4	1) Auxiliary electric heater of sanitary 2) After r12 minutes, boiler	HEAT+SAN	SANITARY	0/1	0/1/2	/	Set up of minutes	2/3	2/3
5	1) Boiler 2) After r12 minutes, auxiliary electric heater of plant/sanitary	HEAT / HEAT+SAN	IN HEAT OR IN SANITARY	0/1	0/1/2	Set up of minutes	Set up of minutes	6	3
6	1) Auxiliary electric heater of plant/sanitary 2) After r12 minutes, boiler	HEAT / HEAT+SAN	IN HEAT OR IN SANITARY	0/1	0/1/2	Set up of minutes	Set up of minutes	3	3
7	1) Boiler	HEAT / HEAT+SAN	HEAT	0/1	0/1/2	Set up of minutes	/	1/3/4/6	0/2
8	1) Auxiliary electric heater of plant	HEAT / HEAT+SAN	HEAT	0/1	0/1/2	Set up of minutes	/	0/2/5	1/3
9	1) Boiler	HEAT+SAN	SANITARY	0/1	0/1/2	/	Set up of minutes	2/3/5/6	0/1
10	1) Auxiliary electric heater of sanitary	HEAT+SAN	SANITARY	0/1	0/1/2	/	Set up of minutes	0/1/4	2/3
11	1) Boiler	HEAT / HEAT+SAN	IN HEAT OR IN SANITARY	0/1	0/1/2	Set up of minutes	Set up of minutes	3/6	0
12	1) Auxiliary electric heater of plant/sanitary	HEAT / HEAT+SAN	IN HEAT OR IN SANITARY	0/1	0/1/2	Set up of minutes	Set up of minutes	0	3

The below Table (5) shows the parameter to be set in order to enable the auxiliary electric heaters in "Summer and sanitary" mode (in this case, the only available auxiliary electric heater is the one of sanitary side and the subdivision between normal/joint/substitution operation is not valid).

TABLE 5. OPERATION IN COOL+SAN MODE (SANITARY MODE IS OPERATING)

N°	ORDER OF INTERVENTION OF AUXILIARY ELECTRIC HEATERS - when the setpoint is not achieved after r16 minutes from the compressor startup or - when the setpoint is not achieved and the unit is in alarm condition.	MODE	OPERATION	r10	r15	r12	r16	r23	r24
1	1) Auxiliary electric heater of sanitary	COOL+SAN	SANITARY	0/1	1	/	Set up of minutes	0/1/2/3/4/5/6	2/3

The below Table (6) shows the behavior of the auxiliary electric heaters of both sanitary and plant in all cases where the unit is operating.

TABLE 6. OPERATION OF AUXILIARY ELECTRIC HEATERS				
N°	MODE	OPERATION	AUXILIARY ELECTRIC HEATER OF PLANT	AUXILIARY ELECTRIC HEATER OF SANITARY
1	HEAT+SAN	HEAT	It works as indicated in the TABLES 1,2,3 and 4.	During "HEAT+SAN" mode operation, the default priority is for the sanitary thermoregulation respecting the plant side heating, so if the thermoregulation is needed, the unit will operate first in "SANITARY" mode, while the auxiliary electric heater of sanitary side behaves as described in the TABLES 1, 2, 3 and 4.
2	HEAT+SAN	SANITARY	<p>Only if the following 3 conditions are fulfilled:</p> <ul style="list-style-type: none"> - Output for auxiliary electric heater of plant side is configured; - r24=1/3; - the water plant remote temperature sensor is installed and configured; <p>the auxiliary electric heater of the plant is active in the below cases:</p> <ul style="list-style-type: none"> - after r12 minutes from the beginning of its counting when activated previously in "HEAT" operation mode (see line N°1); if not already activated its counting in the previous "HEAT" operation mode, after r12 minutes from the thermoregulation requirement. - In DHW (sanitary) mode, if the remote sensor is not set, the auxiliary electric heater of the plant will be disabled or its eventual counting will be stopped. - If the "on-off remote contact" turns to the open state, the auxiliary electric heater of the plant will be turned off. 	It works as indicated in the TABLE 1, 2, 3 and 4.
3	COOL+SAN	SANITARY	Not available.	It works as indicated in the TABLE 5.
4	COOL+SAN	COOL	Not available.	Not available.

11.12.1 Auxiliary systems offset's management

During the joint operation or in substitution operation, for boiler and/or auxiliary electric heaters (depending on your resources and on the selected priorities) it is possible to determine a set-point in heating or sanitary which could be greater than the one of the heat pump. This can be done by setting a temperature offset for the set point:

- **r29**: Temperature offset for boiler and electric heaters of the plant for the first set point (**G02**);
- **r30**: Temperature offset for boiler and electric heaters of the plant for second set point (**G05**);
- **r31**: Temperature offset for boiler and sanitary electric heaters (**G03**).

In this way, the heat pump will stop when achieving the set-point (**G02**, **G03**, **G05**) and the temperature difference can be supplemented by the boiler and/or electric heaters according to the selected temperature offset.

11.13 SIGNALIZATIONS OF FUNCTIONS

If the double set point function is not active, it is possible to activate the signalization of one of the below functions/modes.

11.13.1 Plant's seasonal operation mode

It is possible to set a digital output in order to signalize the operating mode of the unit, plant side.

The digital output is active during summer operation and inactive during heating operation or when the unit is turned off.

During the DHW production and defrosting process, the output subsists in the setting of the former season.

In order to enable such function, you should enter into the parameters as follow: press **PRG**→**PSS**→**PRG**→(then insert the service (maintenance) password)→**PRG**→**PAr**→**PRG**→**CnF**:

I/O Ports -Parameter	Value	Function
"DO7" active by default	H85 =31	Plant system season operation mode signalization

11.13.2 Alarm

It is possible to configure a voltage output to signalize the presence of unlocking alarm.

In order to enable this function, you should enter into parameters **PRG**→**PSS**(insert the maintainer password)→**PAr**→**PRG**→**CnF**.

I/O port- Parameter	Value	Function
DO7 active by default	H85=24	Alarm signalization

11.13.3 Heat pump lockout

It is possible to configure a voltage output to signalize the presence of heat pump lockout alarm.

In order to enable this function, you should enter into parameters PRG→PSS(insert the maintainer password) → PAr→CnF.

I/O port- Parameter	Value	Function
DO7 activable via H85	H85=47	Alarm signalization

11.13.4 Defrosting

It is possible to configure a voltage output to signalize the ongoing defrosting process.

To enable this function, you should enter into the parameters page PRG→PSS (insert the maintainer password) → PAr →CnF.

I/O port – Parameter	Value	Function
“DO7” activable via H85	H85=21	Defrosting process signalization

11.14 DEFROSTING CYCLE

The defrost cycle function is available only in heat pump mode and is used to prevent the frost formation on the surface of the air/air coil. The frost formation on the evaporator, which occurs more frequently at very low ambient temperatures, in addition to greatly decreasing the thermal efficiency of the unit, it can lead to the risk of damaging the unit itself. The adjustable parameters from the maintenance menu are: **5.4 Bar**, for the pressure of initial defrosting process (bar) and **30 Bar**, for setting of the minimum time interval between two consecutive defrosting processes (minutes), it is not recommended to change the default values of these parameters.

If the remote off intervenes during the defrost process, the heat pump terminates to operate in this mode and then goes into remote off mode.

11.15 COMPRESSOR CRANKCASE HEATER

The crankcase heater operates when the compressor remains off for at least 30 minutes and if the discharge temperature is below 20°C (with hysteresis of 2.0°C). When the compressor restarts, the crankcase heater will stop.

11.16 MINIMUM Hz

In order to enable this function, you should enter into the parameters as follow: press PRG→PSS→PRG → (then insert the service password) → PRG → PAr → PRG → LbH.

Configuring parameter L02=1 and L03≠0 reduces the nominal operating Hz of the compressor.

Parameter	VALUE	Function
L02	0	Function not active
	1	Enabling minimum Hz
L03	0	Function not active
	1	Function active only in cooling mode
	2	Function active only in heating mode
	3	Function active only in sanitary mode
	4	Function active in cooling and sanitary mode
	5	Function active in heating and sanitary mode
	6	Function active in cooling and heating mode
7	Function always active	

With the function active, the output and power of the unit are limited, for additional information see the installer user manual.

Configuring a digital input DI9 with parameter H53=21, the function can be managed.

Parameter	VALUE	Function
H53	0 (default)	Function disabled
	21	Open contact -> standard mode Closed contact -> mode Hz min/max

11.17 MAXIMUM Hz

Activating the function increases the power of the unit, please contact us for information.

11.18 DOUBLE SET-POINT (without remote control Touch Screen)

The double set-point function introduces a second working set-point of the plant side (in both cooling and heating modes).

You can configure in the user terminal block a digital input which provide a consent for the transition from the first to the second set-point, and vice versa, determined by humidostat or thermostat (just in case you do not have the touch-screen remote control touch screen).

Setpoint	Setpoint (summer/winter)	Summer	Winter	
First setpoint (°C)	Coo/Hea	7 (5÷18)	45 (35÷60)	DIRECT ZONE
Second setpoint (°C)	Co2/He2	18 (7÷23)	35 (25÷45)	MIXED ZONE

To set the setpoints from the panel on the machine, use the SET key.

The second setpoint is greater than the first setpoint in summer and smaller in winter:

- in summer: $T2 > T1$
- in winter: $T2 < T1$

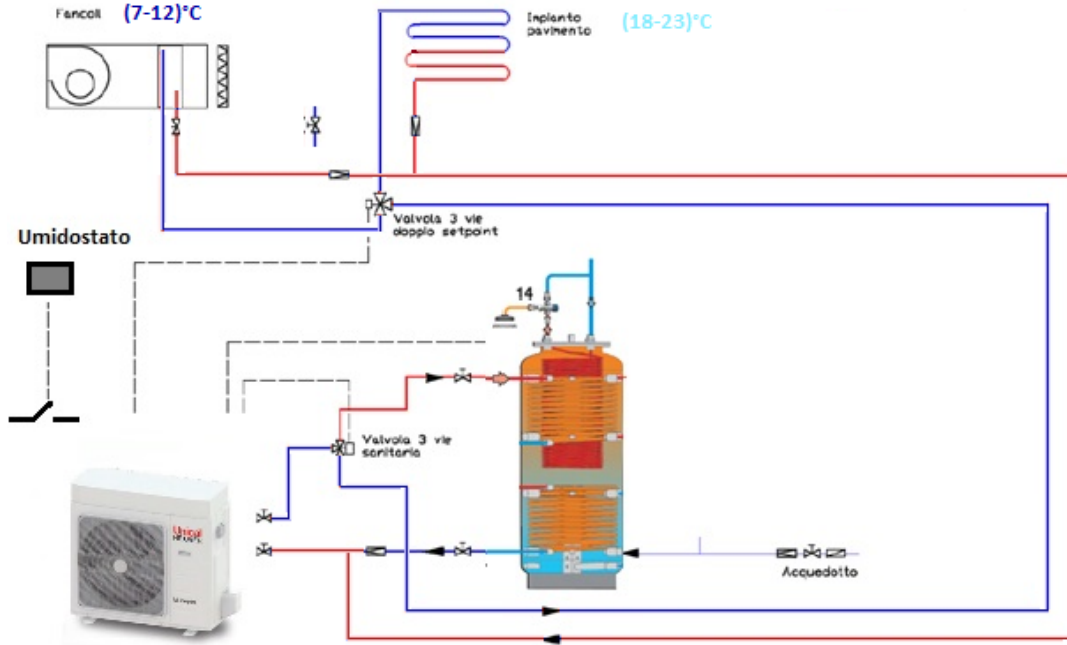

DOUBLE SET POINT HYDRAULIC PRINCIPLE DIAGRAM - COOLING MODE

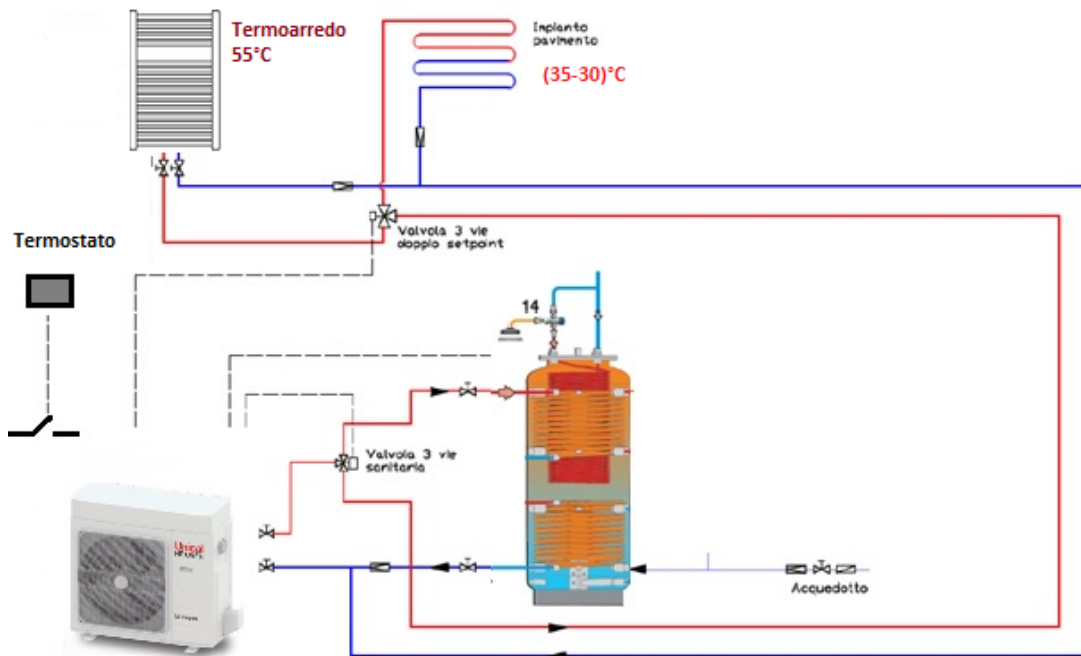

DOUBLE SET POINT HYDRAULIC PRINCIPLE DIAGRAM - HEATING MODE

In presence of consent from humidostat (in summer) or thermostat (in winter) there is the transition from the mixed zone setpoint to the direct zone setpoint.

It is necessary to enable the voltage output in the user terminal block for switching the 3-way valve for the deviation of the flow between the radiant system and the Fan Coil (Cooling) / radiators (Heating).

11.18.1 Control settings

In order to enable such function, you should enter into the parameters as follow: press **PRG**→**PSS**→**PRG** → (then insert the service password) → **PRG** → **PAr** → **PRG** → **CnF**:

I/O Ports - Parameter	Value	Function
H129	0	Disenabled function
	1	Configured and not active
	2	Enabled only in summer mode
	3	Enabled only in winter mode
	4	Enabled in both summer and winter modes
"ID9" digital input activable via H53	H53=26	Call of double set-point (from humidostat / thermostat)
H76	H76=1	Reverse polarity of digital input ID9
"DO7" digital output activable via H85	H85=25	3-way valve for radiant panels

EXAMPLE OF APPLICATION OF THE DOUBLE SET POINT FUNCTION WITH TWO DISTINCT THERMAL ZONES:

In the presence of two distinct thermal zones it is possible to apply the Double Set-Point function in the following way:

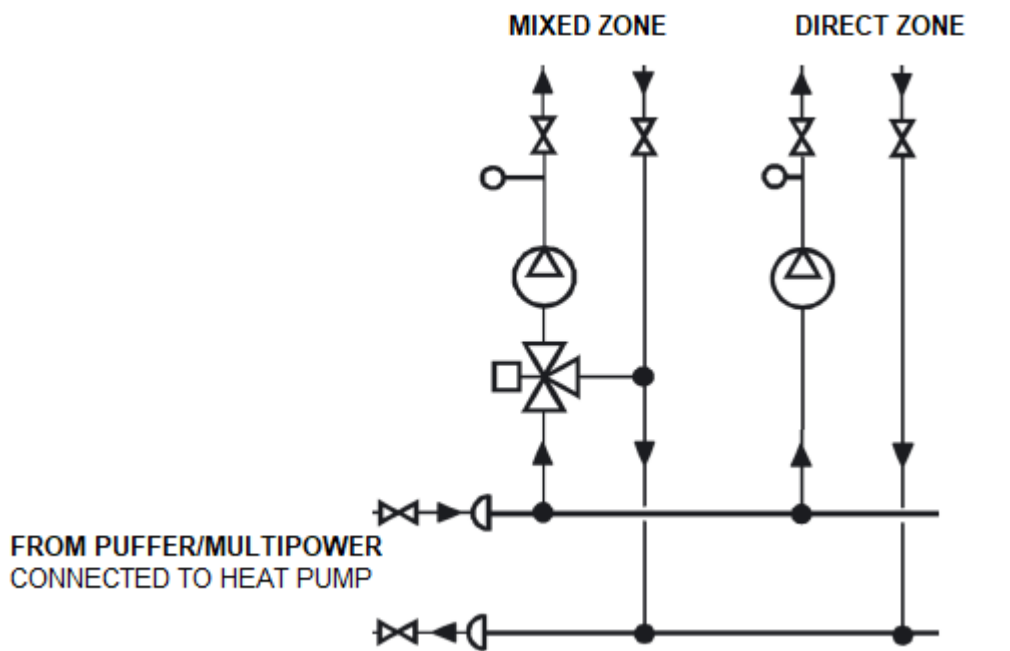

DOUBLE SET POINT HYDRAULIC PRINCIPLE DIAGRAM WITH TWO DISTINCT THERMAL ZONES

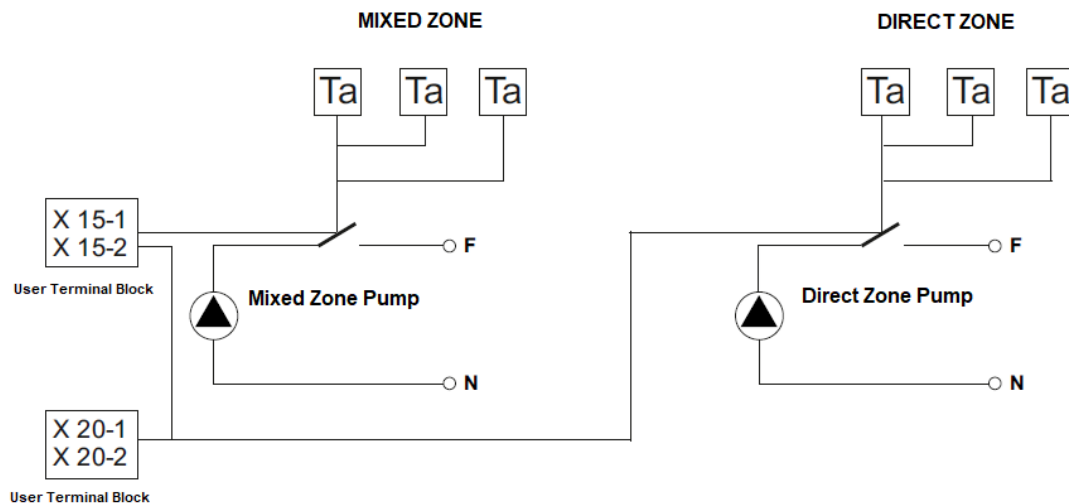

HEATING / COOLING MODE

DOUBLE SET POINT WIRING PRINCIPLE DIAGRAM WITH TWO DISTINCT THERMAL ZONES

In presence of a direct zone (Hea, Co) and a mixed zone (He2 Co2), the consents of both thermal zones must be connected to the remote ON-OFF input (terminals X-15.1 and X-15.2) of the heat pump.

The digital input must be enabled (terminals X-20.1 and X-20.2) to acquire direct zone consent as follows:

I/O Ports - Parameter	Value	Function
H129	0	Disenabled function
	1	Configured and not active
	2	Enabled only in summer mode
	3	Enabled only in winter mode
	4	Enabled in both summer and winter modes
"ID9" digital input activable via H53	H53=26	Call of double set-point (from direct zone)
H76	H76=1	Reverse polarity of digital input ID9

H138	0	DHW second setpoint function disabled (default)
	1	Enabled the second DHW set point in cooling mode
	2	Enabled the second DHW set point in heating mode
	3	Enabled the second DHW set point in cooling and heating mode

12 AVAILABLE FUNCTIONS WITH TOUCH SCREEN CONTROL PANEL ACCESSORY

The "Touch Screen" device is a touch screen remote control panel for centralized management of chiller/heat pump units; it is equipped with humidity and temperature sensors for environment analysis and for managing the double setpoint function for radiant floor systems that are using a dehumidification elements.

The interface of the remote control panel is intuitive, very simple for utilization; the functions are all easy to set through the synoptic use of immediate understanding.

The available functions of the touch screen control panel are listed below:

- Remote management
- Management of a network of heat pumps, up to 7 units;
- Zone thermostat
- Screed function;
- Legionella disinfection;
- Double set-point and dehumidification;
- Dew point control
- Climatic compensation
- Relaunching circulator management
- Management of a single pump for a network
- Alarms diagnostic system

For further information, please see the user's-installer's manual, or contact our offices.

12.1 MANAGEMENT OF SECONDARY CIRCULATOR (with room thermostat)

It allows the management of a secondary or relaunching circulator to service the system.

A room thermostat (N.C.) must be appropriately configured.

- Thermostat contact closed -> The secondary circulator is activated.
- Thermostat contact open → The secondary circulator is switched off with a delay given by P02 (post-pumping).

I/O Ports - Parameter	Value	Function	I/O Ports - Parameter
ID9 can be activated via H53	19	Room thermostat	20.1 / 20.2
DO4 activated via H82	43	Secondary circulator	9.1 (phase) 9.2(neutral)

Heat pump thermoregulation is independent of the thermostat call.

With the heat pump in Off, the relaunching circulator will be turned off independently of the thermostat call

13 USER'S AND INSTALLER'S ALLOWED CONFIGURATIONS

 WARNING	<i>All the operations described below must be carried out only by QUALIFIED PERSONNEL.</i>
	<i>Not all the configurations can be simultaneously enabled and/or changed.</i>
	<i>Other values different than those of default can ensure the proper operation of the unit, in case of doubt about the value to be set contact please our office.</i>
	<i>The company excludes any contractual and extra contractual liabilities for damages caused to persons, animals or objects, by incorrect installation, setting and maintenance, improper use of the equipment, and the partial or superficial reading of the information contained in this guide.</i>

The company declines all responsibility for damages or malfunctions caused by the modifications of the factory default settings of the parameters by third parties, not expressly authorized.

The allowed configurations are shown in the below table, note that, some multiple configurations cannot be selected simultaneously. All the operations that are described below must be carried out only by QUALIFIED PERSONNEL.

Some of the listed parameters are visible and accessible only through the Constructor Password.

Some values that are different from the default ones may ensure the optimal performance of the unit, please contact our offices in case of doubt about the value that to be set.

Notes: (*) Configurable setpoint if the DHW function is activated.

Parameter	Description	Unit	Default	Range	Visibility	Allowed configuration		Note
						Value	Description	
Coo	First setpoint in cooling mode	°C	7.0	H03÷Co2	U			
HEA	First setpoint in heating mode	°C	45.0	He2÷H01	U			
SAn	Domestic water temperature Setpoint	°C	48.0	H02÷H01	U			Configurable set-point if the domestic hot water function is activated
Coo2	Second setpoint in cooling mode	°C	18.0	Coo÷H03	U			
HEA2	Second setpoint in heating mode	°C	35.0	H02÷Hea	U			
H01	Maximum setpoint in heating mode	°C	60.0	-50.0÷80.0	I			It is not recommended to modify such value
H02	Minimum setpoint in heating mode	°C	25.0	-50.0÷80.0	I			It is not recommended to modify such value
H03	Maximum setpoint in cooling mode	°C	23.0	-50.0÷80.0	I			It is not recommended to modify such value
H04	Minimum setpoint in cooling mode	°C	5.0	-50.0÷80.0	I			It is not recommended to modify such value
H10	Activation/deactivation of the sanitary function	/	0	0÷2	I	0	It allows you to deactivate the sanitary function.	
						1	It allows you to activate this function in heating and cooling modes. The remote on-off doesn't disable the DHW production.	
						2	It allows you to activate this function in both heating and cooling modes. The remote on-off function deactivates the DHW production.	
						3	It allows you to activate this function in heating mode. The DHW production will not be deactivated by the remote on-off.	
						4	It allows you to activate this function in heating mode. The DHW production will not be deactivated by the remote on-off.	
						5	It allows you to activate the sanitary function in cooling mode. The DHW production will not be deactivated by the remote on-off.	
H17	Configuration of the analogic input "ST6"	/	0	0÷49	I	0	Analog input "ST6" deactivated	
						6	DHW temperature sensor	
						41	Water temperature remote sensor	
H18	Configuration of the analogic input "ST7"	/	0	0÷49	I	0	Inactive "ST7" analog input	
						6	DHW temperature sensor	
						41	Water temperature remote sensor	
H22	Configuration of 0-10 VDC analog input "ST10"	/	0	0÷49	I	0	Inactive Input	
						40	Plant set-point decalibration.	
H46	Configuration of the digital input "ID2"	/	0	0÷30	I	0	Disenabled input	
						2	Remote On/Off	
						3	Switching between Summer mode and Winter mode	
						19	Room thermostat	
						26	Call of the double setpoint function	
						28	Sanitary call thermostat	
H47	Configuration of the digital input "ID3"	/	2	0÷30	I	0	Disenabled input	
						2	Remote On/Off	
						3	Switching between Summer mode and Winter mode	
						19	Room thermostat	
						26	Call of the double setpoint function	
H51	Configuration of the digital input ID7	/	0	0÷30	I	0	Disenabled input	
						2	Remote On/Off	
						3	Switching between Summer mode and Winter mode	
						19	Room thermostat	
						26	Call of the double setpoint function	
H52	Configuration of the digital input ID8	/	0	0÷30	I	28	Sanitary call thermostat	
						0	Disenabled input	
						2	Remote On/Off	
						3	Switching between Summer mode and Winter mode	
						19	Room thermostat	
						26	Call of the double setpoint function	
						26	Call of the double setpoint function	

Parameter	Description	Unit	Default	Range	Visibility	Allowed configuration		Note												
						Value	Description													
H53	Configuration of the digital input "ID9"	/	0	0÷30	I	28	Sanitary thermostat call													
						0	Disenabled input													
						2	Remote On/Off													
						3	Switching between Summer mode and Winter mode													
						19	Room thermostat													
						26	Call of the double setpoint function													
H75	Digital inputs polarity	/	0	0÷255	I		0 = Normally open (NO) digital inputs 1 = Reversed polarity of DI1 2 = Reversed polarity of DI2 4 = Reversed polarity of DI3 8 = Reversed polarity of DI4 16 = Reversed polarity of DI5 32 = Reversed polarity of DI6 64 = Reversed polarity of DI7 128 = Reversed polarity of DI8													
						H76	Digital inputs polarity	/	0	0÷255	I		0 = N.O. Digital inputs 1 = Reversed polarity of DI9 2 = Reversed polarity of DI10 4 = Reversed polarity of DI1E1 8 = Reversed polarity of DI2E1 16 = Reversed polarity of DI3E1 32 = Reversed polarity of DI4E1 64 = Reversed polarity of DI5E1 128 = Reversed polarity of DI6E1							
												H81	Configuration of DO3 under-voltage output	/	22	0÷47	I	0	Output deactivation	
																		6	Sanitary valve	
																		7	Active circulator signal replication	
																		21	Defrosting signalization	
																		22	Plant integration electric heater	
24	Alarm signalization																			
25	Double setpoint valve																			
26	Sanitary integration electric heater																			
29	Activation of the boiler																			
31	Signalization of Summer/Winter mode operation																			
43	Secondary circulator																			
H82	Configuration of the under-voltage output "DO4"	/	14	0÷47	I	0	Output deactivation													
						6	Sanitary valve													
						7	Active circulator signal replication													
						14	Plate exchanger antifreeze heater (if the KA antifreeze kit is present, this output is not available)													
						21	Defrosting signalization													
						22	Plant integration electric heater													
						24	Alarm signalization													
						25	Double setpoint valve													
						26	Sanitary integration electric heater													
						29	Activation of the boiler													
31	Signalization of Summer/Winter mode operation																			
H83	Configuration of the under-voltage output "DO5"	/	28	0÷47	I	43	Secondary circulator													
						47	Machine lock-out notification													
						0	Output deactivation													
						6	Sanitary valve													
						7	Active circulator signal replication													
						21	Defrosting signalization													

Parameter	Description	Unit	Default	Range	Visibility	Allowed configuration		Note
						Value	Description	
						22	Plant integration electric heater	
						24	Alarm signalization	
						25	Double setpoint valve	
						26	Sanitary integration electric heater	
						28	EU exchanger base antifreeze heater (if the KA antifreeze kit is present, this	
						29	Activation of the boiler	
						31	Signalization of Summer/Winter mode operation	
						43	Secondary circulator	
						47	Machine lock-out notification	
						0	Output deactivation	
						6	Sanitary valve	
						7	Active circulator signal replication	
						21	Defrosting signalization	
						22	Plant integration electric heater	
						24	Alarm signalization	
						25	Double setpoint valve	
						26	Sanitary integration electric heater	
						29	Activation of the boiler	
						31	Signalization of Summer/Winter mode operation	
						43	Secondary circulator	
						47	Machine lock-out notification	
						0	Output deactivation	
						6	Sanitary valve	
						7	Active circulator signal replication	
						21	Defrosting signalization	
						22	Plant integration electric heater	
						24	Alarm signalization	
						25	Double setpoint valve	
						26	Sanitary integration electric heater	
						29	Activation of the boiler	
						31	Signalization of Summer/Winter mode operation	
						43	Secondary circulator	
						47	Machine lock-out notification	
H126	Serial address	/	1	1÷200	I		In case of utilization of two or more HP_POWER ONE units in cascade configuration, each proper controller should have its specified address.	
						0	Deactivation of the function	See par. Errore. L'origine riferimento non è stata trovata.
						1	Function configured but not active	
						2	Function enabled in cooling	
						3	Function enabled in heating	
						4	Function enabled in cooling and heating	
						0	Normal operation	
						1	In heating mode, the unit always reverted towards the sanitary mode.	
						0	Function configured but not active	
						1	Function enabled in cooling	
						2	Function enabled in heating	
						3	Function enabled in cooling and heating	
A03	Bypass flow-switch from pump activation	sec	10	0÷255	I		Other values that are different from the default one may ensure optimal operation of the unit.	The alarm is not active for duration of A03 from the activation of the pump.
A08	Set of antifreeze alarm activation	°C	3	-127÷127	I		Other values that are different from the default one may ensure optimal operation of the unit.	
A09	Anti-freeze alarm hysteresis	°C	3.0	0.0÷25.5	I			
A16	Low pressure setting in cooling mode	Bar	Depending on the model	-50,0÷80,0	I		Other values that are different from the default one may ensure optimal operation of the unit.	

Parameter	Description	Unit	Default	Range	Visibility	Allowed configuration		Note
						Value	Description	
A27	Low pressure set in heating	Bar	Depending on the model	0.0÷25.5				
b01	Cold band	°C	1,0	0÷255				
b02	Hot band	°C	1,0	0÷255				
b03	Sanitary Differential	°C	3,0	0÷255				
b04	Commutation duration of the radiant panels valve	sec	30	0÷600			Other values that are different from the default one may ensure optimal operation of the unit.	
b05	Compressor cut-off hysteresis in cold and hot	°C	0.2	0.0÷25.5				
b06	Sanitary exit transitory in heating mode	sec	45	0÷255			See par. 6	
b07	PI regulator integral time	sec	150	0÷255			See par. 6	
b08	Enabling of dynamic set	/	0	0÷1			See par. 6	
b09	Maximum offset in cooling mode	°C	3.0	-50.0÷80.0			See par. 6	
b10	Maximum offset in heating mode	°C	-3.0	-50.0÷80.0			See par. 6	
b11	Outdoor air temp. setpoint in cooling	°C	25	-127÷127			See par. 6	
b12	Outdoor air temp. setpoint in heating	°C	15	-127÷127			See par. 6	
b13	Temperature differential in cooling	°C	-10.0	-50.0÷80.0			See par. 6	
b14	Temperature differential in heating	°C	10.0	-50.0÷80.0			See par. 6	
b15	Decalibration band set from analog input 0-10V	/	5.0	0.0÷10.0			See par. 7	
b16	Scan time of compressors start-up	sec	60	0÷255				
b20	Enabling of the inputs 0-10V/ratiometric	/	0	0÷1		0	0-10V input	
						1	Ratiometric input	
b22	Thermoregulation cut-off Hysteresis plant sensor	°C	5	0.0÷25.5				See paragraph 11.6
b25	Cut-on hysteresis of the compressor in cooling and heating	°C	2.0	0.0÷25.5				
P01	Pump ON compressor ON time delay	sec	30	0÷255				
P02	Pump OFF compressor OFF time delay	min	1.0	0÷25.5				
P03	Pump operation mode	/	0	0÷1		0	Continuous operation	The pump is always operating if the antifreeze electric heaters are ON (see chap. 8)
						1	Thermoregulation operation	
P04	Pump setting in antifreeze operation	°C	5	-15÷15			See par. 8	
P05	Pump hysteresis in antifreeze mode	°C	2.0	0.0÷15.0			See par. 8	
P06	Pump proportional band in heating	°C	according to the model	0.0÷25.0				
P07	Maximum speed of modulating pump	%	100	0÷100				
P08	Minimum speed of modulating pump	%	Depending on the model	0 - 100			See par. 8	
P09	Set of ΔT between water inlet and water outlet of heat pump	°C	2	0÷15			See par. 8	
P10	Temperature differential of modulating pump	°C	2.0	0.0÷25.0				
P16	Duration between 2 activations of the pump in periodic mode	min	0	0÷600			See par. 8	
P17	Operating time of the pump in periodic mode	sec	0	0÷255			Periodic mode is disabled	

Parameter	Description	Unit	Default	Range	Visibility	Allowed configuration		Note
						Value	Description	
P18	Enabling of unique pump operation in network	/	0	0÷1	I			
P19	Unique pump operation in network in presence of offline machines	/	0	0÷1	I			
r02	Set point of anti-freeze heaters in heating	°C	4	3÷6	I			
r03	Set point of anti-freeze heaters in cooling	°C	4	3÷6	I			
r06	Anti-freeze electric heaters differential	°C	2,0	0,0÷25,5	I			
r08	Upper limit during substitution operation	°C	-20	-16÷50	I		Respect the condition r22 ≥ r28 ≥ r08	
r09	Hysteresis for heat pump lockout	°C	1.0	0.0÷25.5	I			
r10	Activation of the auxiliary electric heaters of the plant	/	0	0÷1	I	0	Inactive function	See chapter 11.7
						1	Active function	
r11	ΔT[°C] of the plant auxiliary electric heater	°C	0,5	0,0÷25,5	I		See par. 10.5.1	
r12	Activation time delay of the plant/heat pump auxiliary electric heater	min	10	0÷255	I		See par. 10.5.1	
r13	Auxiliary heater deactivation delay	min	10	0÷255	I			
r14	Exclusive electric heaters operation	/	0	0÷1	I	0	Electric heaters can be activated at the same time	
						1	Electric heaters can be activated not all at the same time	
r15	Activation of sanitary auxiliary electric heater	/	0	0÷2	I	0	Inactive function	See paragraph 11.7
						1	Active function	
						2	Operation of auxiliary plant-side electric	
r16	Time delay of activation of the auxiliary electric heater of sanitary circuit/heat pump	/	15	0÷255	I			
r19	Activation period of drain pan heaters from last defrost operation	min	10	0÷255	I	0	Activation of the electric heater independently than the defrosting operation	
r20	Priority for utilizing the electric heaters	/	1	0÷1	I	0	Priority for plant side	The setting of this parameter is necessary only if r14 = 1.
						1	Priority for DHW side	
r21	Enabling the mitigation to plant side with heaters in defrost	/	0	0÷1	I	0	Inactive function	
						1	Active function	
r22	Band I joint operation upper limit	/	7	-16÷50	I		Respect the condition r22 ≥ r28 ≥ r08	
r23	Types of utilization of the boiler	/	6	0÷6	I	0	Boiler not used	See paragraph 11.10
						1	Use of boiler in plant integration (Priority of intervention for the electric heaters)	
						2	Use of boiler in DHW integration (Priority of intervention for the electric heaters)	
						3	Use of boiler in plant and DHW integrations (Priority of intervention for the electric heaters)	
						4	Use of boiler in plant integration (Priority of intervention for the boiler)	
						5	Use of boiler in DHW integration (Priority of intervention for the boiler)	
6	Use of boiler in plant and DHW integrations Priority of intervention for the boiler							
r24	Types of utilization of the auxiliary electric heaters	/	3	0÷3	I	0	Auxiliary electric heaters not used	See paragraph 11.7
						1	Plant auxiliary electric heater	
						2	DHW auxiliary electric heater	
						3	Auxiliary electric heaters of both sanitary and plant circuits	
r25	Anti-legionel disinfection setpoint	°C	80	0÷100	I			Activable and configurable function by mean of the remote control panel accessory Hi-T .
r26	Disinfection period	min	12	0÷255	I			
r27	Setting for heat pump operation in disinfection mode	°C	48.0	-50.0÷80.0	I			

Parameter	Description	Unit	Default	Range	Visibility	Allowed configuration		Note
						Value	Description	
r28	Upper limit for joint operation band II	°C	-7	-16÷50	I		Respect the condition $r22 \geq r28 \geq r08$	
r29	Temperature offset for boiler and heaters of the plant, first setpoint (HEA)	°C	0	0÷100	I			See paragraph 11.12.1
r30	Temperature offset for boiler and heaters of the plant second setpoint (HEA2)	°C	0	0÷100	I			
r31	Temperature offset for boiler and sanitary circuit heaters (SAN)	°C	0	0÷100	I			
r32	Boiler's endowment	/	1	0÷3	I	0	Boiler without circulator with thermoregulation by the heat pump unit	See paragraph 11.10
						1	Boiler without circulator with self-thermoregulation	
						2	Boiler equipped with circulator and thermoregulation to carried out by "HP"	
						3	Boiler without circulator with self-thermoregulation	
r33	Management of the pump with active electric heaters	/	3	0÷3	I	0	Circulator active under compressors call for eventual boiler request (see r32)	See paragraph 11.9
						1	The circulator is active if the plant electric heater is active	
						2	The circulator is active if the DHW electric heater is active	
						3	The circulator is active if the plant or the DHW electric heater is active	
d02	defrost start pressure	bar	5,4	-50÷80	I		Other values that are different from the default one may ensure optimal operation of the unit.	
d04	defrost stop pressure	bar	21	0÷50	I		Other values that are different from the default one may ensure optimal operation of the unit.	
d08	Minimum interval between two defrosts	min	30	0÷255	I		Other values that are different from the default one may ensure optimal operation of the unit.	
n06	Compressor block mode	/	0	0÷1	I		Other values that are different from the default one may ensure optimal operation of the unit.	
L02	User enablement for maximum Hz	/	0	0÷1	I	0	Disabled function	See paragraph 11.16
						1	Enabled function	
L03	Hz maximum	/	0	0÷7	I			See paragraph 11.16

14 ALARMS

14.1 WATER FLOW SWITCH ALARM [E006]

The water side flow switch is already installed inside the unit and DOES NOT HAVE to be tampered with or by-passed in any way. The flow switch is by-passed for **10** seconds after the unit's start up. The alarm signal occurs after 5 seconds of the error appearance (lack of water flow, air inside the circuit, etc.). The alarm will automatically reset itself for the first two times and it will be deactivated after 5 seconds: the alarm is active and the circulator is activated for **120** seconds.

If the alarm happens more than 3 times per hour, you should manually reset it.

The alarm is not active in the below situations:

- During the domestic hot water production
- During the purging cycle of the system.

14.2 HIGH TEMPERATURE [E018]

The alarm will be activated when the outlet water temperature sensor becomes higher than **65°C** for **50** seconds. It turns off when the water outlet temperature decreases below **62°C**.

14.3 ANTI-FREEZING [E005]

The alarm will be activated when the outlet water temperature sensor is less than **A08 (3°C)**. It turns off when the temperature becomes higher than **+6°C**. The alarm will be bypassed for **120** seconds from the turning on of the unit in heating mode.

14.4 SENSOR ALARMS [E611÷E692]

The alarm will be activated in the case of a short or open circuit of any connected and enabled sensor.

The alarm will be activated also when the temperature becomes higher than the sensors' upper limit of **100°C** or less than the lower limit of **-50°C**.

A temperature sensor configured as a sensor for sanitary mode, does not lead to alarm if the sanitary mode is not enabled.

14.5 TIMEOUT INVERTER [E801]

Supposing the controller does not communicate with the driver board of the compressor, the time out alarm will be activated in order to prevent a system's control loss.

14.6 INVERTER [E851÷E971]

The inverter board has its own alarm list.

14.7 REMOTE ON/OFF [E00]

In this case the unit is controlled remotely from digital input.

14.8 HIGH PRESSURE [E001]

If the on board pressure transducer detects a pressure higher than **41,5 bar**, the alarm will be activated.

In this case the compressor will stop immediately. The alarm will reset when the pressure decreases under **32,5 bar**.

If the alarm occurs more than 3 times per hour, the alarm becomes at manual reset.

14.9 HIGH PRESSURE FLOW SWITCH (IN SERIES WITH THE COMPRESSOR OUTLET PROBE) [E641]

If the pressure switch on the machine detects a pressure higher than **42,8 bar** driver and compressor are not powered, the alarm will be active and the error **E641** probe (Compressor discharge probe failure) appears.

The alarm resets when the pressure drops below **34 bar**.

If the number of alarm interventions in one-hour is equal to 3 times, it will become a manual reset.

14.10 LOW PRESSURE [E002]

In chiller mode, If the pressure transducer installed on the unit detects a pressure lower than **3,5 bar**, the alarm will be ON. The alarm is not active 60 seconds after the startup of the compressor.

In heat pump mode, if the pressure transducer on the machine detects a pressure lower than **1.3 bar**, the alarm is active.

The alarm goes off when the pressure rises **2.0 bar** compared to the intervention threshold.

Each time the compressor is activated, a bypass time of 60 seconds is counted (alarm not active).

When the alarm is ON, the compressors in the circuit and the outdoor fans will stop operation.

If the number of alarm interventions in one-hour is equal to 3 times, it becomes a manual reset.

Note: After turning off the machine, all its own alarms will reset and the number counting the interventions of the relative alarms will reset also.

14.11 DRIVER LIMITATION [E008]

If the compressor does not reach the ramp speed value within **30** minutes, the alarm becomes active and the compressor will stop for safety.

The alarm becomes manual rest if it occurs for 3 times in one hour.

14.12 4-WAY VALVE [E041]

Manual re-arm alarm, identifies a malfunctioning of the 4-way valve due to inversion.

The alarm is not active for a bypass time of approximately 180 seconds from the compressor startup.

- In heating or DHW mode, the alarm is active when the bypass time has expired with water supply temperature less than the heat pump water return temperature -1°C.
- In cooling mode the alarm is active when the bypass time has been expired with water supply temperature greater than the heat pump water return temperature +1°C.

14.13 DOMESTIC HOT WATER PROTECTION [E042]

The Alarm is active when the water supply sensor of the heat pump detects a temperature equal to **H01** (60°C), the compressor is stopped, if present, auxiliary heating systems work with the related offset up until the DHW setpoint detected by the DHW sensor is not satisfied or the digital input does not disable the DHW call.

The compressor restarts when the supply temperature of the heat pump detects a temperature equal to **H01-4°C** (56°C) and a signal to the thermo-regulator is present.

It is not recommended to modify the H01 parameter, different values may compromise proper machine operation.

14.14 POWER SUPPLY FAILURE

After power supply reset:

1. The system comes back to the previous state before the power failure.
2. If the system is defrosting, this mode will be cancelled after power supply reset.
3. All the running timings will be cleared and reset again.

14.15 [E020] INVERTED TRANSDUCERS

With active compressors, if the suction pressure probe measures a pressure higher than the condensing pressure probe, then alarm E020 is signaled.

This alarm cannot be reset (power must be removed from the machine to eliminate the alarm) and is not managed in defrost.

14.16 USER BLOCK ALARM LIST

Error code	Error description	Lockout
E00	Remote turn OFF	Circuit
E001	High pressure	Circuit
E002	Low pressure	Circuit
E005	Anti-freezing alarm	Machine
E006	Flow switch error	Machine
E008	Compressor driver limitation alarm	Circuit
E009	High discharge temperature	Circuit
E010	Solar collector high temperature error	Solar pump
E018	High temperature error in cooling operation	Machine
E020	Alarm Inverted Transducers	Machine
E041	4 Way Valve / Incongruous temperatures alarm	Machine
E042	DHW Protection / Poor heat exchange error	Machine / sanitary
E050	Sanitary tank high temperature alarm	
E101	Communication timeout with Slave 1	Machine
E611	Inlet water temperature sensor error	Machine
E621	Outlet water temperature sensor error	Machine
E631	Compressor inlet temperature sensor	Machine
E641	Compressor outlet temperature sensor error / high pressure switch intervention	Machine
E651	Outside air temperature sensor error	Machine
E661	DHW sensor error	Machine
E671	Plant remote sensor error	Machine
E691	Low pressure transducer fault	Machine
E701	High pressure transducer error	Machine
E711	Input 0-10Vdc failure	Machine
E801	Timeout inverter	Compressor
E851	Inverter hardware error	Compressor
E861	Motor current is too high	Compressor
E871	High temperature of inverter heatsink (Heatsink over-heat protection)	Compressor
E881	Power supply voltage outside limits (DC Bus Error)	Compressor
E891	Compressor disconnected from the power supply (Driving protection-output phase loss)	Compressor
E901	Compressor driver and model mismatch	Compressor
E911	Overload protection	Compressor

Error code	Error description	Lockout
E921	PFC-POE overcurrent protection	Compressor
E931	Communication error with main controller	Compressor
E941	PFC converter fault	Compressor
E951	Heatsink and/or room temperature sensor error	Compressor
E961	Abnormal condition	Compressor
E971	EEPROM not initialize	Compressor

15 MODBUS VARIABLES

The control introduces default the next configuration:

BAUD RATE	9600
PARITY	EVEN
DATA BIT	8
STOP BIT	1
DEVICE ID	1

To configure the Modbus communication depending on your needs, it is necessary to modify the next registers:

H124 : BAUD RATE	
0	4800
1	9600
2	19200
3	38400

H125 : PARITY, STOP BIT	
0	NONE, 2 bit
1	ODD, 1 bit
2	EVEN, 1 bit
3	NONE, 1 bit

H126 : DEVICE ID	1 ÷ 200
------------------	---------

Commands Modbus:

READ	3 (HOLDING REGISTER)
WRITE	6-16

Register	Format	Bit	R/W	Range	Name	Description	Note
1	INT	-	R	-	Data version	Firmware version	
2	INT	-	R	-		Firmware release	
3	BYTE (H)	-	R	-		Firmware sub-release	
	BYTE (L)	-	R	-		Firmware creation day	
4	BYTE (H)	-	R	-		Firmware creation month	
	BYTE (L)	-	R	-		Firmware creation year	
80 ÷ 97	ASCII	-	R	-	Serial number	Registration number	
1089	INT		R/W	1 ÷ 200	Serial address	Modbus serial ID	
200	INT		R/W	-	Machine setting	(0) Stand by	Machine status reading values
			R/W	-		(1) Cooling	
				-		(2) Heating	
			R/W	-		(4) Sanitary	

Register	Format	Bit	R/W	Range	Name	Description	Note
			R/W	-		(5) Cooling + *Sanitary	
			R/W	-		(6) Heating + *Sanitary	
7201	BIT MASK	0	R/W	-		Remote enabling of machine status writing	Required for 7200 register
7200	INT	-	W	-		(0) Stand by	Writing illegal values at this address can lead to unexpected operations, then stick to only the values allowed for writing.
		-	W	-		(1) Cooling	
		-	W	-		(2) Heating	
		-	W	-		(3) Sanitary	
		-	W	-		(4) Cooling + *Sanitary	
		-	W	-		(5) Heating + *Sanitary	
7201	BIT MASK	1	R/W	-		Enable remote setpoint writing	Required for 7203/7208 register
7203	°C/10	-	R/W	5.0 ÷ 23.0	Set point	Cooling	
7204	°C/10	-	R/W	25.0 ÷ 55.0		Heating	
7205	°C/10	-	R/W	25.0 ÷ 55.0		Sanitary	
7206	°C/10	-	R/W	5.0 ÷ 23.0		Cooling second setpoint	
7207	°C/10	-	R/W	25.0 ÷ 55.0		Heating second setpoint	
7208	°C/10	-	R/W	0.0 ÷ 80.0		Preparing DHW	
7201	BIT MASK	2	R/W	-	Second setpoint	Enable pass to second setpoint	Required for 7202 register
7202	BIT MASK	0	W	-		0 = setpoint 1, 1 =setpoint 2	Write value.
7217	BIT MASK	0	R	-		0 = setpoint 1, 1 =setpoint 2	Read value
7201	BIT MASK	3	R/W	-	room call	Enabling write remote environment call	Required for 7202 register bit 1
7202	BIT MASK	1	R/W	-		Forcing remote room call	
7201	BIT MASK	4	R/W	-	sanitary call	Enabling write remote sanitary call	Required for 7202 register bit 2
7202	BIT MASK	2	R/W	-		Forcing remote sanitary call	
7201	BIT MASK	5	R/W	-	Anti-legionella ²	Remote enabling of anti-legionella cycle	Required for 7202 register bit 3
7202	BIT MASK	3	R/W	-		Remote activation of the anti-legionella cycle request	The bit must remain at 1 for the entire cycle time.
		5				Anti-legionella cycle in progress	
7216	BIT MASK	6	R	-		Anti-legionella cycle failed	It remains at 1 until the next cycle, or it is reset when the board is turned off.
7202	BIT MASK	5	R/W	-	System vent	Forcing system vent	Only if it is in Stand By (0).
7202	BIT MASK	6	R/W	-	Sanitary disablement	Sanitary call inhibition (without exiting the + SAN mode)	Active only if bit 3 of 7201 is set (when the room call is also managed remotely).
7202	BIT MASK	7	R/W	-	Defrosting	Defrosting forced	Only if the machine is in heating (2-6).
7214	BIT MASK	13	R	-		Sbrinamento in chiamata	
		14				Sbrinamento in corso	
305	ora	-	R	-	Operating hours	compressor 1	
307	ora	-	R	-		compressor 2	
309	ora	-	R	-		compressor 3	

Register	Format	Bit	R/W	Range	Name	Description	Note					
313	ora	-	R	-		compressor 1 circuit 2						
315	ora	-	R	-		compressor 2 circuit 2						
317	ora	-	R	-		compressor 3 circuit 2						
253	°C/10	-	R	-	Transducer temperature	Evaporation						
254	°C/10	-	R	-		Condensation						
626	°C/10	-	R	-		Evaporation circuit 2						
627	°C/10	-	R	-		Condensation circuit 2						
400	°C/10	-	R	-	Temperature	Water inlet temp.						
401	°C/10	-	R	-		Water outlet temp.						
405	°C/10	-	R	-		DHW temperature	If active					
422	°C/10	-	R	-		Compressors Aspiration						
428	°C/10	-	R	-		Outside temperature						
433	°C/10	-	R	-		Compressor "1" discharge temp.						
434	°C/10	-	R	-		Compressor "2" discharge temp.						
435	°C/10	-				Compressor "3" discharge temp						
437	°C/10	-				Solar Collector						
438	°C/10	-				Solar Storage						
440	°C/10	-	R	-		Plant remote temperature						
443	°C/10	-	R	-		Radiant panels mixing flow						
447	°C/10	-	R	-		DHW preparer recirculation						
20422	°C/10	-	R	-		Compressors Aspiration circuit 2						
20433	°C/10	-	R	-		Compressor "1" discharge temp. Circuit 2						
20434	°C/10	-	R	-		Compressor "2" discharge temp. Circuit 2						
20435	°C/10	-	R	-		Compressor "3" discharge temp. Circuit 2						
406	bar/100	-	R	-		Pressure	High					
414	bar/100	-	R	-			Low					
20406	bar/100	-	R	-			High circuit 2					
20414	bar/100	-	R	-	Low circuit 2							
7000	%/10	-	R	-	Analog Output	Condensation fan						
7001	%/10	-	R	-		Circulating pump						
627	%/10	-	R	-		Condensation fan cir 2						
950	BIT MASK	0	R	-	ALARM - E001	* High pressure	Reset alarms by writing the value 0 using the command 6 on one of any alarm area registers					
		1			ALARM - E002	* Low pressure						
		2			ALARM - E003	* Thermal protection of compressor 1						
		3			ALARM - E004	* thermal protection of fan1						
		4			ALARM - E005	Frozen water						
		5			ALARM - E006	Flowswitch						
		6			ALARM - E007	*DHW preparer low temperature						
		7			ALARM - E008	Constrained stop of compressors for lubrication lack						
		8			ALARM - E009	Temperature discharge is high						
		9			ALARM - E010	*Alta temperatura collettore solare						
		12			ALARM - E013	*thermal protection of compressor 2						
		13			ALARM - E014	*Thermal protection of fan 2						
		15			ALARM - E016	*Thermal protection of pump 1						
		951			BIT MASK	1		R	-	ALARM - E018	High temperature	
						2				ALARM - E019	High discharge temperature Cp2	
3	ALARM - E020		Inverted pressure transducers									
6	ALARM - E023		Thermal compressor 3									

Register	Format	Bit	R/W	Range	Name	Description	Note
		7			ALARM – E014	Fan thermal 3	
		9			ALARM – E026	* Thermal protection of pump 2	
		11			ALARM – E041	Incongruous temperature	
		12			ALARM – E042	Poor heat exchange	
		13			ALARM – E050	Sanitary tank high temperature	
		14			ALARM - E101	GI 1 module is disconnected	
		15			ALARM - E102	GI 2 module is disconnected	
952	BIT MASK	0	R	-	ALARM - E611	Sensor error 1	
		1			ALARM - E621	Sensor error 2	
		2			ALARM - E631	Sensor error 3	
		3			ALARM - E641	Sensor error 4	
		4			ALARM - E651	Sensor error 5	
		5			ALARM - E661	Sensor error 6	If active
		6			ALARM - E671	Sensor error 7	If active
		7			ALARM - E681	Sensor error 8	If active
		8			ALARM - E691	Sensor error 9	
		9			ALARM - E701	Sensor error 10	
		10			ALARM - E711	Sensor error 11	If active
		11			ALARM - E612	*Gi module – Sensor 1	If active
		12			ALARM - E622	* Gi module – Sensor 2	If active
		13			ALARM - E632	*Gi module – Sensor 3	If active
		14			ALARM - E642	*Gi module - Sensor 4	If active
		15			ALARM - E652	*Gi module – Sensor 5	If active
953	BIT MASK	0	R	-	ALARM - E662	*Gi module – Sensor 6	If active
		1			ALARM - E672	*Gi module – Sensor 7	If active
		2			ALARM - E682	*Gi module – Sensor 8	If active
		3			ALARM - E692	*Gi module – Sensor 9	If active
		4			ALARM - E702	*Gi module – Sensor 10	If active
		5			ALARM - E712	*Gi module – Sensor 11	If active
		6			ALARM – E613	*Gi module 2 – Sensor 1	
		7			ALARM – E623	* Gi module 2– Sensor 2	
		8			ALARM – E633	*Gi module 2– Sensor 3	
		9			ALARM – E643	*Gi module 2- Sensor 4	
		10			ALARM – E653	*Gi module 2– Sensor 5	
		11			ALARM – E663	*Gi module 2– Sensor 6	
		12			ALARM – E673	*Gi module 2– Sensor 7	
		13			ALARM – E683	*Gi module 2– Sensor 8	
		14			ALARM – E693	*Gi module 2– Sensor 9	
		15			ALARM – E703	*Gi module 2– Sensor 10	
954	BIT MASK	0	R	-	ALARM – E713	*Gi module – Sensor 11	
		1			ALARM - E801	Link inverter 1	
		2			ALARM - E802	Link inverter 2	
		3			ALARM - E803	Link inverter 3	
		4			ALARM - E851	Hardware fault inverter 1	
		5			ALARM - E852	Hardware fault inverter 2	
		6			ALARM - E853	Hardware fault inverter 3	
		7			ALARM - E861	Overcurrent inverter 1	
		8			ALARM - E862	Overcurrent inverter 2	
		9			ALARM - E863	Overcurrent inverter 3	
		10			ALARM - E871	High temperature inverter 1	

Register	Format	Bit	R/W	Range	Name	Description	Note
		11			ALARM - E872	High temperature inverter 2	
		12			ALARM - E873	High temperature inverter 3	
		13			ALARM - E881	Bad voltage inverter 1	
		14			ALARM - E882	Bad voltage inverter 2	
		15			ALARM - E883	Bad voltage inverter 3	
955	BIT MASK	0	R	-	ALARM - E891	Phase sequence inverter 1	
		1			ALARM - E892	Phase sequence inverter 2	
		2			ALARM - E893	Phase sequence inverter 3	
		3			ALARM - E901	Model error inverter 1	
		4			ALARM - E902	Model error inverter 2	
		5			ALARM - E903	Model error inverter 3	
		6			ALARM - E911	Overload error inverter 1	
		7			ALARM - E912	Overload error inverter 2	
		8			ALARM - E913	Overload error inverter 3	
		9			ALARM - E921	Overcurrent PFC inverter 1	
		10			ALARM - E922	Overcurrent PFC inverter 2	
		11			ALARM - E923	Overcurrent PFC inverter 3	
		12			ALARM - E931	Internal communication error inverter 1	
		13			ALARM - E932	Internal communication error inverter 2	
		14			ALARM - E933	Internal communication error inverter 3	
956	BIT MASK	0	R	-	ALARM - E941	Fault PFC inverter 1	
		1			ALARM - E942	Fault PFC inverter 2	
		2			ALARM - E943	Fault PFC inverter 3	
		3			ALARM - E951	Probe error inverter 1	
		4			ALARM - E952	Probe error inverter 2	
		5			ALARM - E953	Probe error inverter 3	
		6			ALARM - E961	Abnormal condition inverter 1	
		7			ALARM - E962	Abnormal condition inverter 2	
		8			ALARM - E963	Abnormal condition inverter 3	
		9			ALARM - E971	EEPROM inverter 1	
		10			ALARM - E972	EEPROM inverter 2	
		11			ALARM - E973	EEPROM inverter 3	
		12			ALARM - E029	Cp3 high discharge temperature	
		13			ALARM - E060	Anti-legionella performed correctly	

¹⁾ if enabled

²⁾ the cycle is activated only if the machine status includes domestic hot water (4-5-6)

³⁾ if value read equal to 32766 the probe is not configured, if 32767 the probe is faulty

⁴⁾ reset alarms, write the value 0 on any of the alarm area registers with command 6

⁵⁾ the alarms of circuit 2 are mapped in the same way with an offset of 20000 (e.g. 20950)

Unical[®]



www.unical.eu

00338956EN - ed. 4 - 05/2022

Unical[®] AG S.p.A. 46033 casteldario - mantova - italia - tel. +39 0376 57001 - fax +39 0376 660556
info@unical-ag.com - export@unical-ag.com - www.unical.eu

Unical will not be held responsible for possible inaccuracies if due to transcription or printing errors. It also reserves the right to modify its products as deemed necessary or useful, without jeopardising their essential features.